



SN

FTM 5003

**Flash Remote Telemetry Unit
Reference Manual**

Front Matter

Abstract

This manual contains information and instructions for installing, operating, and maintaining the FTM 5003 Flash Remote Telemetry Unit.

Copyright

Copyright © 2002, Flash Technology Corporation of America®, Franklin TN 37067, U.S.A.

All rights reserved. Reproduction or use of any portion of this manual is prohibited without express written permission from Flash Technology Corporation of America and/or its licensor.

Trademark Acknowledgments

Flash Technology Corporation of America® is a registered trademark name.

Flash™, ElectroFlash™, Flash Tech™, Flash Technology™, FTCA™, and the Flash Technology Logo are all trademarks of Flash Technology Corporation of America®.

All trademarks and product names mentioned are properties of their respective companies, and are recognized and acknowledged as such by Flash Technology Corporation of America.

Disclaimer

While every effort has been made to ensure that the information in this manual is complete, accurate and up-to-date, Flash Technology Corporation of America assumes no liability for damages resulting from any errors or omissions in this manual, or from the use of the information contained herein. Flash Technology Corporation of America reserves the right to revise this manual without obligation to notify any person or organization of the revision.

In no event will Flash Technology Corporation of America be liable for direct, indirect, special, incidental, or consequential damages arising out of the use of or the inability to use this manual.

Warranty

FTCA warrants all components, under normal operating conditions, for one year.

Parts Replacement

The use of non-OEM parts or unauthorized modification of this equipment will void the warranty.

PERSONNEL HAZARD WARNING

DANGEROUS VOLTAGES

Dangerous line voltages reside in certain locations in this equipment. Although FTCA has incorporated every practical safety precaution, exercise extreme caution at all times when you expose circuits and components, and when you operate, maintain, or service this equipment.

Avoid Touching Live Circuits

Avoid touching any component or any part of the circuitry while the equipment is operating. Do not change components or make adjustments inside the equipment with power on.

Do Not Depend on Interlocks

Never depend on interlocks alone to remove unsafe voltages. Always check circuits with a voltmeter. Under no circumstances remove or alter any safety interlock switch.

Table of Contents

	Page
Section 1 — FTM 5003 Introduction and Operation.....	1-1
System.....	1-1
Specifications.....	1-1
Operation.....	1-1
TB1 on the main panel:.....	1-1
5100 Power Supply Board:.....	1-1
Standard Data Points in the FTM 5003:.....	1-2
5100 Power Supply Board.....	1-2
5110 CPU Card.....	1-5
Section 2 — Outline, Mounting, and Installation.....	2-1
Unpacking.....	2-1
Tools.....	2-1
Access.....	2-1
Mounting.....	2-1
FTM 5003 RTU.....	2-1
Installation.....	2-1
Wiring.....	2-1
Grounding.....	2-1
Lightning Protection.....	2-2
Installation Checklist.....	2-2
Section 3 — Maintenance and Troubleshooting.....	3-1
Maintenance.....	3-1
Troubleshooting.....	3-1
General Guidelines.....	3-1
Component Removal and Replacement.....	3-1
All Add-on Cards, CPU, & Modem.....	3-1
5100 Power Supply Board.....	3-1
5105 Backplane Board.....	3-2
Storage.....	3-2
Section 4 — Replaceable and Spare Parts.....	4-1
Customer Service.....	4-1
Ordering Parts.....	4-1
Flash Site Monitor Parts.....	4-1
Returning Equipment.....	4-1
Repackaging.....	4-1

List of Figures

Figure 1-1 5100 Power Supply Board.....	1-4
Figure 1-2 5110 CPU Card.....	1-6
Figure 1-3 5105 Backplane Board.....	1-7
Figure 1-4 5107 Backplane Extender Board.....	1-7
Figure 1-5 FTM 5003 Assembly Showing Optional Add-on Cards.....	1-8
Figure 1-6 FTM 5003 Assembly Backplane Layout.....	1-9
Figure 2-1 FTM 5003 Mounting and Outline.....	2-3
Figure 2-2 FTM 5003 Wiring Schematic.....	2-4

	Page
Figure 3-1 FTM 5003 Communication Failure Flow Chart	3-3
Figure 4-1 FTM 5003 Component Locations	4-3

List of Tables

Table 1-1 FTM 5003 Standard Data Points	1-2
Table 1-2 Switches, Connectors, LEDs, and Test Points	1-3
Table 1-3 5110 CPU Card Jumpers & LEDs	1-5
Table 4-1 FTM 5003 Major Replaceable Parts	4-1

Page left intentionally blank.

Section 1 — FTM 5003 Introduction and Operation

System

The FTM 5003 Remote Telemetry Unit provides remote monitoring of various types of inputs, with some control outputs, including but not limited to the monitoring of obstruction lighting systems. With the FTM 5003 unit connected to the customers' equipment and a communications uplink through either a telephone line (POTS or cellular) or an Ethernet connection to a remote computer running EAGLE Software, FTCA or the customer can monitor the operation of a remote site. For instance, if monitoring an obstruction lighting system, information can be obtained on the number of flashes, room temperature, strobe energy, photocell state, current applied to beacons and markers, bank voltage, service source power and dry contact alarm outputs provided by site equipment. The FTM 5003 thus provides nearly instant notification of light failure, site power failure or equipment failure.

EAGLE software is also used to set up the FTM 5003 from the monitoring location.

Internal battery back up allows FTM 5003 operation during power failures to report structure power loss.

Specifications

Specifications are listed for a single FTM 5003

Physical

FTM 5003: *Physical (Height x Width x Depth, Wgt.):*

7.75 x 13.5 x 6 in., 15 lbs.
20 x 34 x 15 cm., 7 kg.

NEMA 4X Fiberglass, UL50, UL94 5V
Aerodynamic Wind Area:

Flash Site Monitor .73 ft.², .07 m.²

Performance Characteristics

Electrical:

AC Voltage 24, 115, 230 VAC, 60 Hz

DC Voltage 24 VDC

Watts: 40 Watts

Mode Relay Contact Rating 125 V at 10 A

Operation

The FTM 5003 begins to operate as soon as power is applied. An interlock switch cuts power to the hardware when the door is opened. The unit remains powered by its 12 volt battery, but the interlock switch removes (turns off) input power. ***In the event of a power loss, the unit will remain on battery until the battery voltage drops to 10.5 volts, after which the unit will shutdown to prevent from draining the battery too low and causing permanent damage. AC power is required for the system to power up (if AC power and the battery are disconnected and the battery is plugged back up, the unit still will not come on).***

WARNING: Power must be off and the battery disconnected before removing or adding any boards to the system.

The following connections are provided:

TB1 on the main panel: Power source lines are connected to the terminal block TB1-1, -2, and -3.

5100 Power Supply Board: RS-232 and RS-485 serial connections are available on J6 (see *Figure 1-1*). J8 is used to connect additional backplane boards. A 5105 Backplane board (see *Figure 1-3*) is used to extend the communication's bus and various types of I/O cards can be used on this board. The terminal block J4 on the 5105 board is used to make the

external connections to your various I/O points. A ground lug is also utilized for each 5105 board to attach the drain wire of the incoming connections. Additional 5105 boards can be plugged into J1 on subsequent 5105 boards to extend the communication's bus. To install a 5105 Backplane Board, a new row must be started by using the 5107 Backplane Extender board (see *Figure 1-4*). The 5107 board is used by plugging J1 of the 5107 into J8 of the 5100 board. J1 of the first 5105 board is plugged into J2 of the the 5107. After that, additional 5105 boards are added by plugging J1 of new 5105 boards into J2 of the subse-

quent 5105 boards, for a total of 3 backplane boards. See *Figure 1-5* and *Figure 1-6* for illustrations.

Standard Data Points in the FTM 5003: There are a number of standard data points in the FTM 5003 that can be configured to generate an alarm. These points are listed in *Table 1-1*. If a point is configured to alarm in certain conditions, the alarm will reset itself once the condition changes.

Table 1-1 FTM 5003 Standard Data Points

Data Point	Description
Current Mode	Day, Night, or Auto
Mode Switch	Mode switch position :Day,Night, or Auto
Eagle Mode	Day, Night, or Auto
Photocell State	Day, Night, or Auto
Photocell Timeout	Minutes Since Last Transition
Line Voltage %	Measurement of FTM 5003 source VAC
Line Frequency	FTM 5003 VAC line frequency (Hz)
Board Temperature	Temperature of the board (deg C)
Battery Voltage	Voltage of 12 VDC Battery Back-up
Battery Status	Condition of battery: OK,Fault
Enclosure Door Detection	Enclosure Door is Opened or Closed
Power Status	AC or Battery
Communication Card	Type of modem/communication

5100 Power Supply Board

The 5100 Power Supply Board in conjunction with the 5110 CPU card and the 5115 Modem card provides the controls and modem neces-

sary to communicate sensor information to the remote computer.

5100 Power Supply board has switches, connectors, LEDs, and test points whose functions are described in *Table 1-2*.

Table 1-2 Jumpers, Switches, Connectors, LEDs, and Test Points

Item	Description
Manual Override Switch SW1	Auto: Normal operating position. Day/night status of lamps is based upon photocell position. Day: manual override to day mode; if left in this position for over 8 hours, the board changes back to Auto mode. Night: manual override to night mode; if left in this position for over 8 hours, the board changes back to Auto mode.
J1	Input Power (24, 115, 230 VAC, 24 VDC) Factory configured
J2	Door Intrusion Input
J3	Battery connection
J4	Photocell input
J5	Mode Relay Output
J6	RS-232 and RS-485 Serial Connections
J7	RS-232 Serial Connection. <i>Temporary connection point.</i>
LED 11	485RX - RS-485 Receive Data
LED 12	485TX - RS-485 Transmit Data
LED 13	232TX - RS-232 Receive Data
LED 14	232RX - RS-232 Transmit Data
LED 15	NIGHT - Night Mode
LED 16	DAY - Day Mode
LED 17	BATTERY POWER - On battery power
TP1	GND - System Common
TP2	DC_UNREG - Unregulated DC Supply; ~28-32 VDC
TP3	16VDC - Bus Supply Voltage
TP4	5VDC - Processor & Modem Supply Voltage
TP5	VBAT - Bus Battery Backup Supply
TP6	VCHARGER - Battery Charger Voltage (13.7 - 14.3 VDC)
JP1	Photocell Test - Short forces day mode
JP2	External RS-485 Termination - LO
JP3	External RS-485 Termination - AB
JP4	External RS-485 Termination - HI

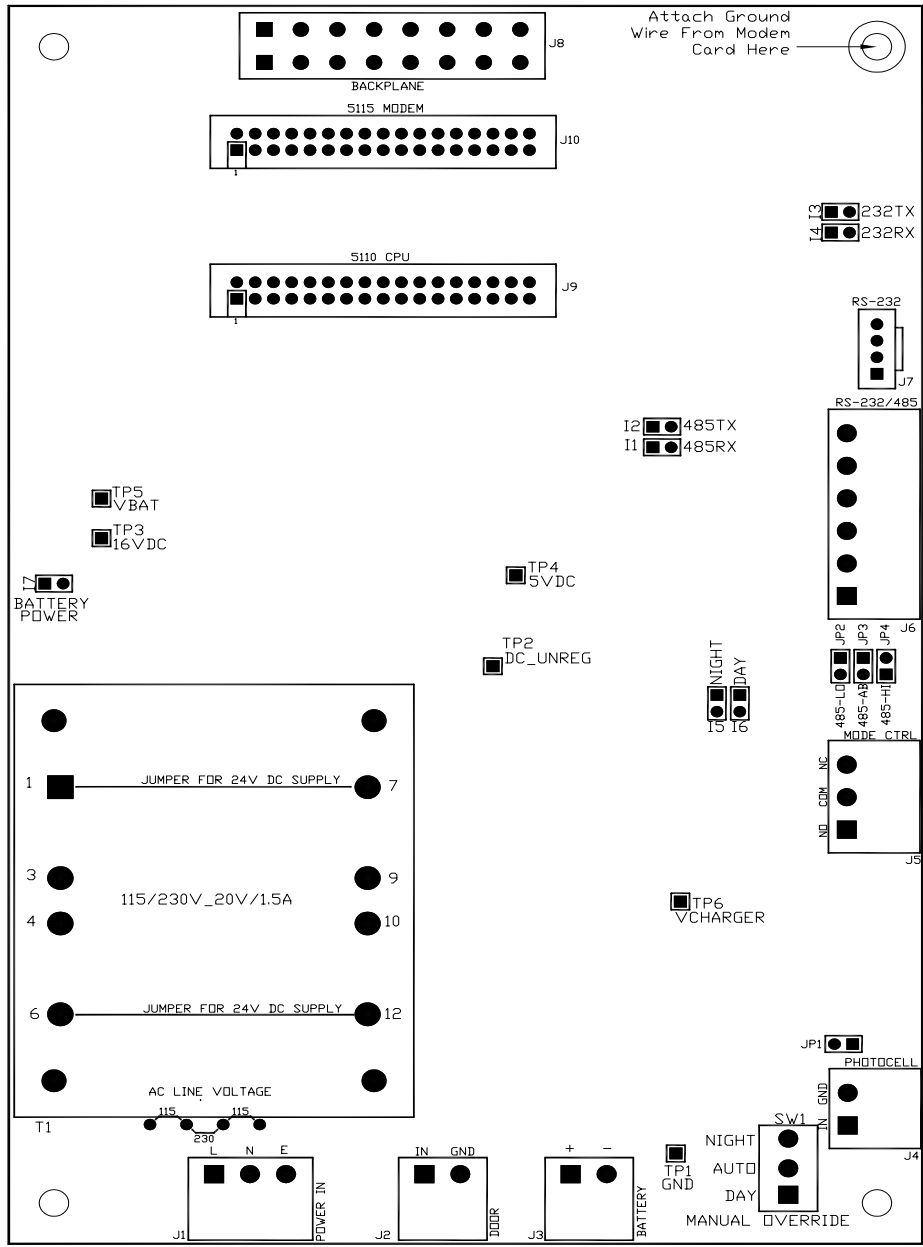

Figure 1-1 5100 Power Supply Board

5110 CPU Card

The 5110 CPU card is the central processing unit for the entire system. It is where all of the data is collected and interpreted. The CPU card has an Ethernet 10baseT port for direct connectivity with a full function TCP/IP stack and is SNMPv1 compliant with configurable traps. The CPU card also supplies the RS-485

and RS-232 serial connections to communicate with the rest of the system as well as external units (these connections are made through the 5100 Power Supply Board).

5110 CPU Card has jumpers, connectors, and LEDs whose functions are described in *Table 1-3*. *Figure 1-2* provides a pictorial of the 5110 CPU card.

Table 1-3 5110 CPU Card Jumpers & LEDs

Item	Description
JP1-1	MD1 - No Jumper Installed, factory reserved
JP1-2	MD0 - Jumper Hardwired, factory installed
JP1-3	RXD1 - Jumper In, factory installed
LED I1	TX - Ethernet Transmit Data, blinks when transmitting data
LED I2	RX - Ethernet Receive Data, blinks when receiving data
LED I3	LNK - Ethernet Link, illuminated if connected via ethernet port
LED I4	PEC - Photocell Error, Comes on when no mode over 19 hour period.
LED I5	HRT - Heartbeat, shows that the CPU is working properly if blinking

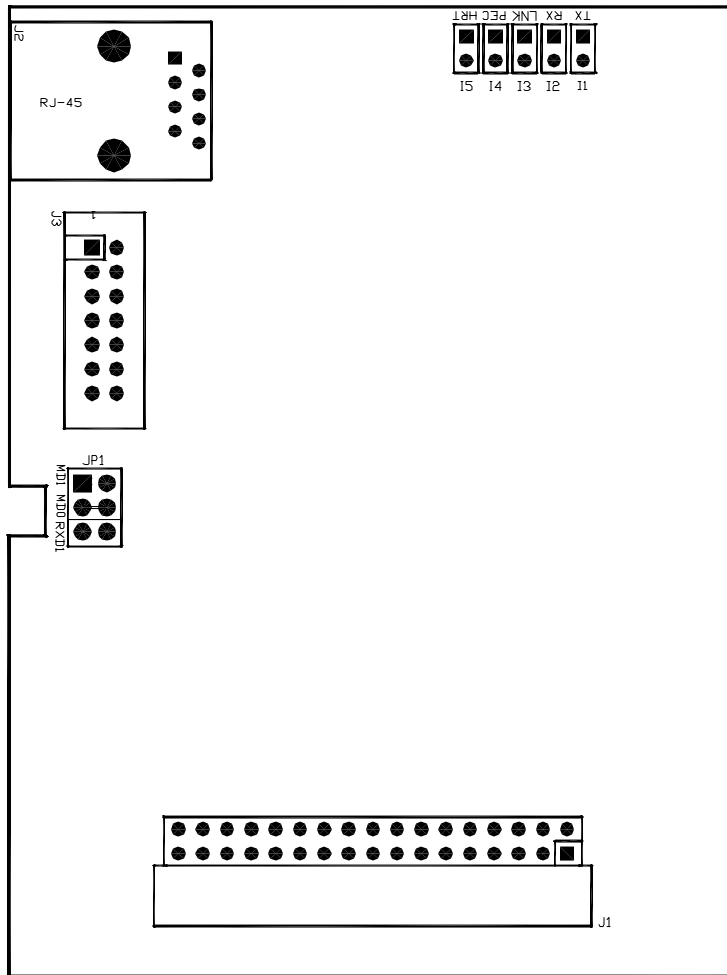

Figure 1-2 5110 CPU Card

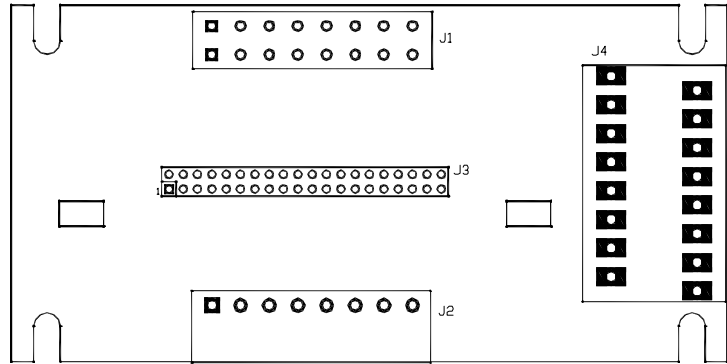

Figure 1-3 5105 Backplane Board



Figure 1-4 5107 Backplane Extender Board

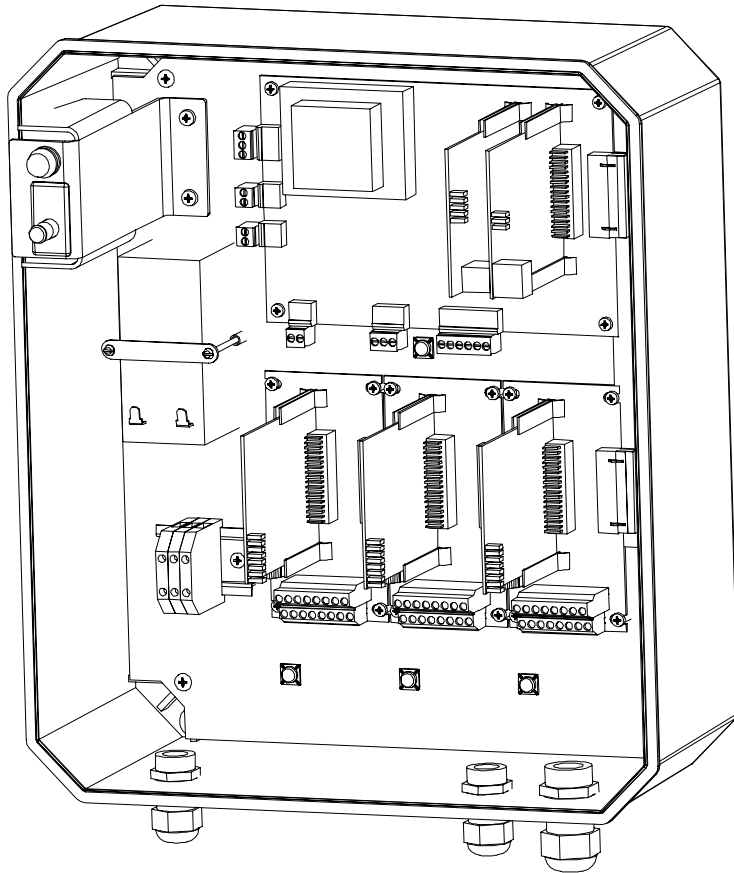

Figure 1-5 FTM 5003 Assembly Showing Optional Add-on Cards

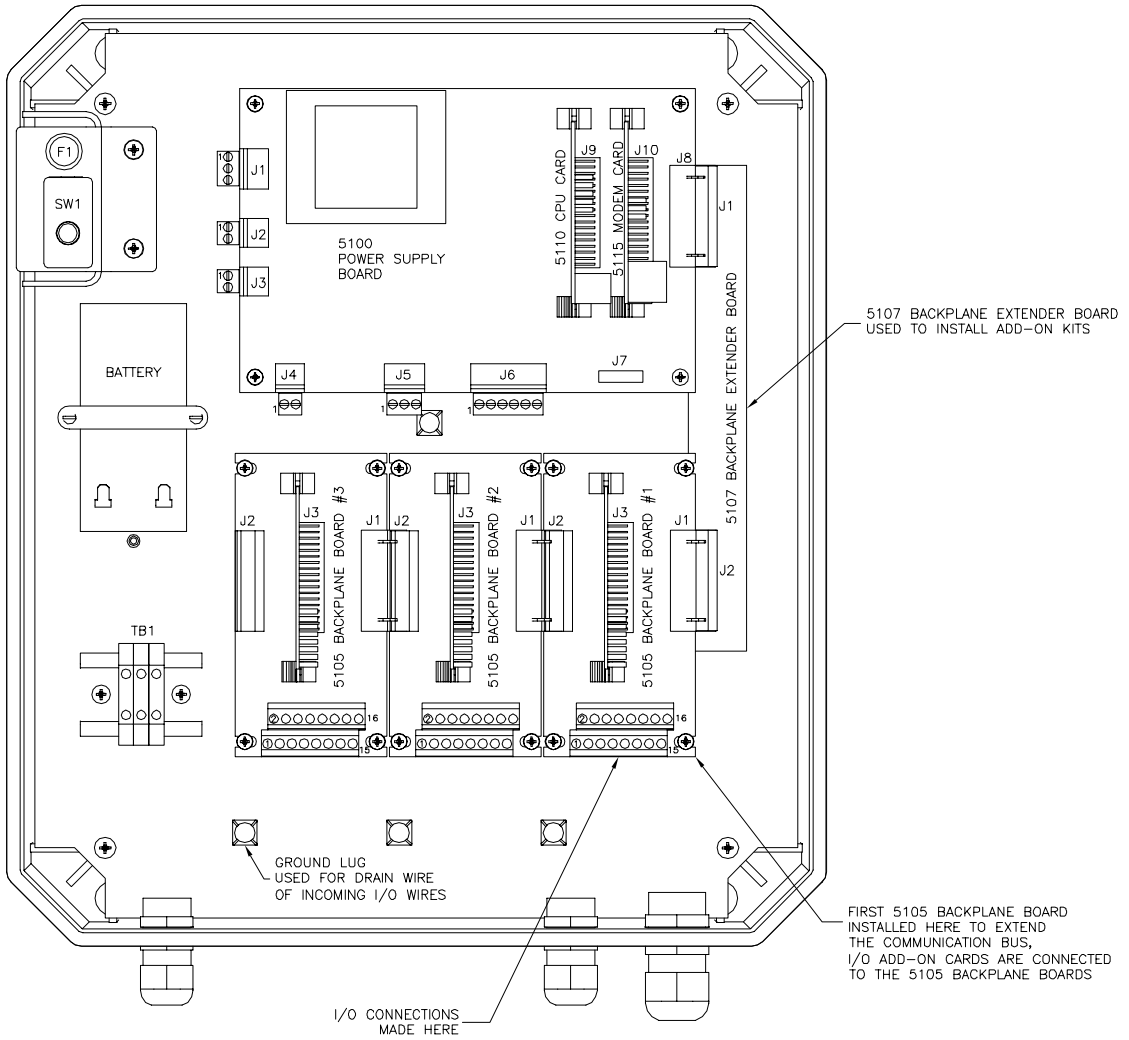

Figure 1-6 FTM 5003 Assembly Backplane Installation

Page left intentionally blank.

Section 2 — Outline, Mounting, and Installation

Unpacking

Inspect shipping cartons for signs of damage before opening. Check package contents against the packing list and inspect each item for visible damage. Report damage claims promptly to the freight handler.

Tools

- Hand tools for electrical wiring
- Small $\frac{5}{32}$ " flat blade screwdriver
- Phillips-head #2 screwdriver
- Medium flat-blade screwdriver
- 8" or 10" adjustable wrench

Access

WARNING

STOP: Before proceeding, read the warning on Page iii. Disconnect primary power before opening cover.

Latches secure the door. When you release these, you can open the cover for internal access.

Mounting

FTM 5003 RTU

Mounting and outline dimensions are shown in *Figure 2-1*.

Mounting feet are shipped unattached and are located inside the unit. Using the enclosed screws, attach the mounting feet to the back of the enclosure. Mount the FTM 5003 vertically so that the door opens to the left. Mount it as close as possible to the equipment that it will

be monitoring. Interior mounting is preferred but not required.

Installation

Wiring

This manual may not contain all the information about installation wiring required for your installation.

NOTE

If installation drawings prepared specifically for your site disagree with information provided in this manual, the site installation drawings should take precedence. Consult any site-specific installation wiring diagram supplied with your equipment.

FTCA wiring diagrams define only minimum requirements recommended for satisfactory equipment operation. It is the responsibility of the installer to comply with all applicable electrical codes.

Follow all local and national electrical codes.

The FTM 5003 Remote Telemetry Unit consumes less than 40 Watts of power fully loaded. Protect the FTM 5003 with a dedicated standard 15 amp single-pole circuit breaker. ***Do not use the same breaker as the equipment it will be monitoring.***

A description of the wiring necessary for the I/O cards used in the system is given in the appropriate Appendix detailing that card.

Grounding

For lightning protection, surge protection, and safety, it is very important that you ground

the FTM 5003 enclosure to the site grounding system.

Lightning Protection

All Flash equipment is designed to withstand severe transient over-voltages. However, a lightning arresting system should be installed to prevent eventual damage by lightning. Transient suppressors from line-to-line and line-to-neutral are recommended at the primary power load center.

Installation Checklist

Use the following checklist when installing the system:

1. **Equipment Damage:**
Inspect all equipment for damage.
2. **Required Equipment:**
Verify the received equipment against the packing list to ensure completeness.
3. **Consult site installation drawings for placement, mounting, wiring details, and power phasing.**
4. **Provide a dedicated circuit breaker.**
5. **Check the lightning protection system.**
6. **Be sure that junction boxes will drain properly.**
7. **FTM 5003 RTU Mounting: Position and mount the FTM 5003 allowing adequate clearance for opening the door and servicing the components. Also, use the following guidelines:**
 - Ensure that the unit is mounted upright and grounded to the site grounding system.

- Check internal hardware to ensure that the chassis mounting screws are tight.
- Ensure that no holes are punched or drilled on the top surface of the cover.
- Ensure that air can flow around the case.

8. FTM 5003 RTU Wiring:

Examine the installation drawings and use the following guidelines:

- Check for proper incoming service voltage. Verify that primary power voltage is the value stated on the ID plate.
- Wire each unit according to the instructions.
- Check all electrical connections for tightness.
- Check all terminal strip connections for tightness.
- It is very important that you ground the FTM 5003 to the site grounding system. The ground terminal on TB1 also grounds the backplate through the din rail.
- Ground all communication cable shields to the FTM 5003 RTU at the appropriately located ground lugs.

After completing all the steps listed above, turn on the power and perform an operational checkout from procedures in Section 3 of this manual.

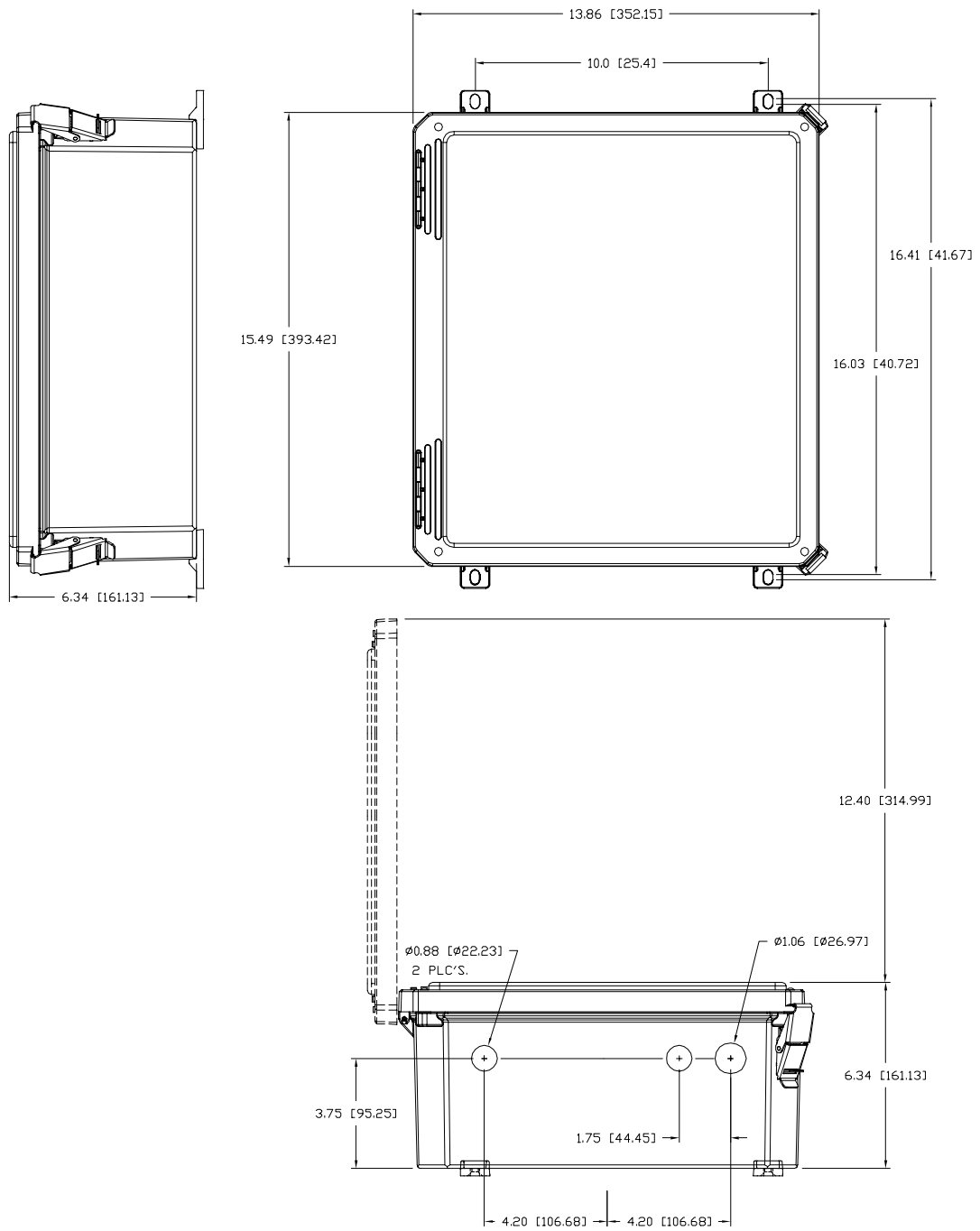

Figure 2-1 FTM 5003 Mounting and Outline

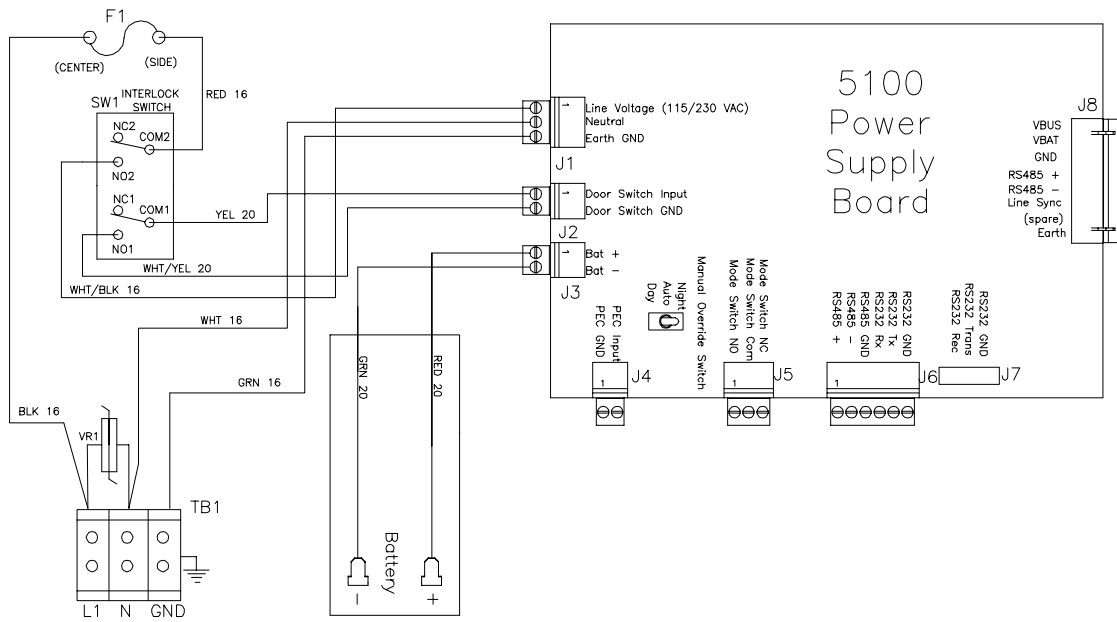

Figure 2-2 FTM 5003 Wiring Schematic

Section 3 — Maintenance and Troubleshooting

Maintenance

No scheduled maintenance is required for this equipment although the circuit boards should be kept free of accumulated dust. Brush and vacuum as necessary.

NOTE

Do not use compressed air for cleaning this equipment.

Troubleshooting

The most effective troubleshooting procedure begins with observing the behavior of the system. This often leads directly to a faulty component or other abnormal condition.

General Guidelines

- The presence of an illuminated red LED will indicate an alarm or fault of some kind. Most of the time, however, this should also indicate that the system is running properly as far as it has been setup through EAGLE (i.e. all cards are functioning properly).
- If you suspect that a particular card is not working properly or not communicating, try reseating the card with the power off and the battery unplugged before replacing it.
- The Heartbeat LED (I5) on the 5110 CPU card will blink to indicate that the CPU is running correctly. If the LED is off or steady, then the CPU is not working for some reason (see *Figure 3-1*).

A flowchart is shown in *Figure 3-1* that describes the steps to take if a communication failure is suspected with the unit. This would include: not being able to dial into the unit, the unit does not call out, not getting readings

from certain cards, etc. If a particular add-on card is suspected to be malfunctioning, follow the troubleshooting instructions for that card in the Appendix designated for that card.

Component Removal and Replacement

The following procedures describe the removal and replacement of selected components that may require procedures that are not self-evident.

All Add-on Cards, CPU, & Modem

With the power off and the battery disconnected, grab the edges of the card with your left hand close to the end of the card. With your right hand grip the right plastic card guide and, with your thumb, press down the tab to release the lock. While pressing the tab, pull the card out with your left hand. To replace the card, you will have to slide the card down both guides with the locking tab being pressed out of the way. The cards should seat all of the way down onto the backplane board and the lock will keep it from vibrating loose.

5100 Power Supply Board

- Remove the CPU and modem card (if present)
- Remove the 4 mounting screws.
- Pull down and slightly move the board side-to-side to disconnect J8 (8 pin connector at the top of the board). You will have to move the bottom of the board slightly to the right to pull it all of the way out to avoid the interlock switch bracket.

5105 Backplane Board

Unless the board to be replaced is the last one in line, you will need to take out all of the mounting screws for every backplane board immediately after it in order to remove it. Backplane boards should rarely have to be changed.

Storage

No special considerations are required for long-term storage of the equipment. Circuit boards, when not installed in the equipment, should be kept in antistatic bags or containers.

FTM 5000 Communication Failure

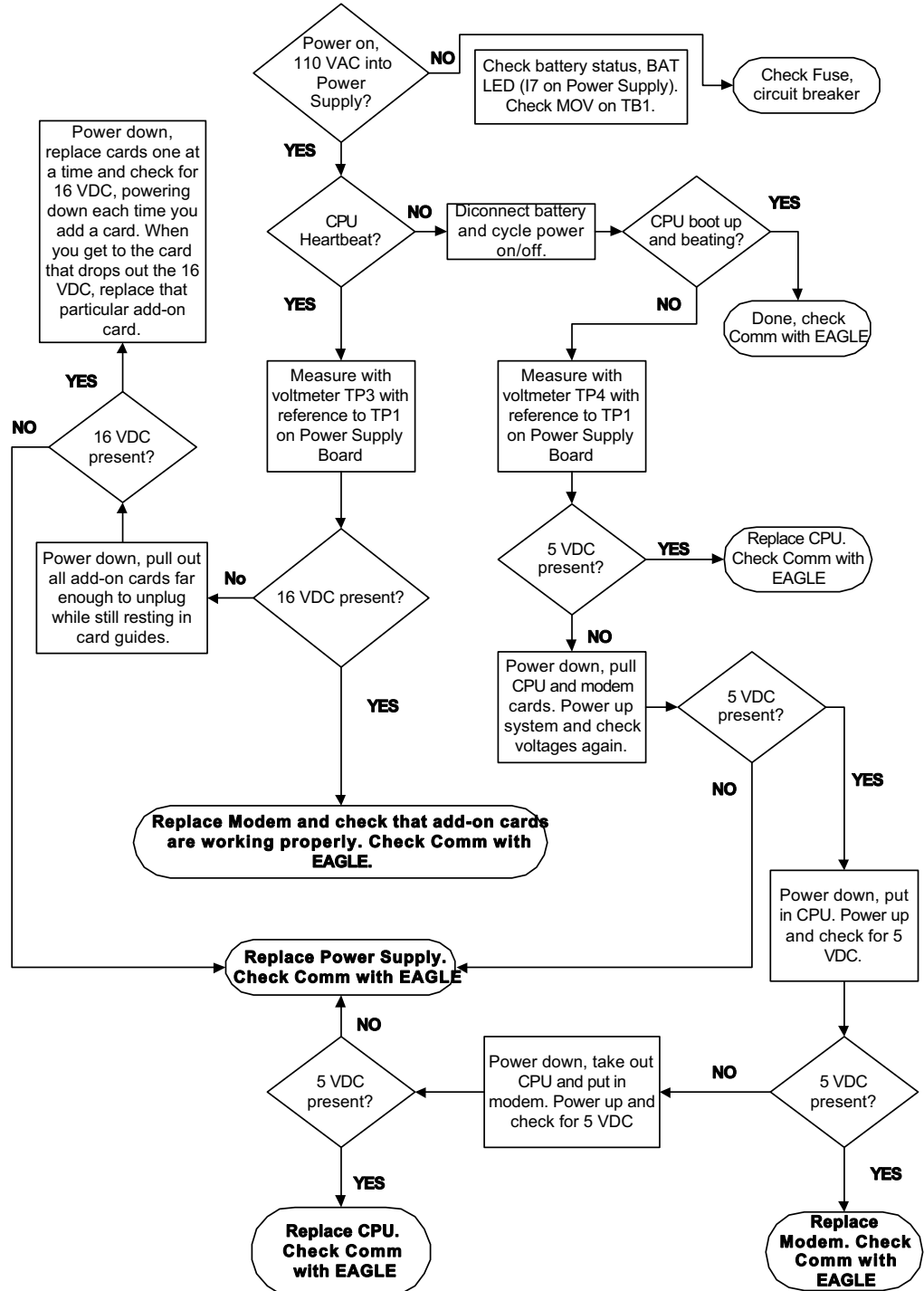

Figure 3-1 FTM 5003 Communication Failure Flow Chart

Page left intentionally blank.

Section 4 — Replaceable and Spare Parts

Customer Service

Customer Service 1-800-821-5825

FTCA Telephone: (615) 261-2000

Facsimile: (615) 261-2600

Internet Address:

<http://www.flashttechnology.com>

Shipping Address:

Flash Technology Corporation of
America

332 Nichol Mill Lane

Franklin TN 37067

Ordering Parts

To order spare or replacement parts, contact FTCA customer service at 1-800-821-5825.

Flash Site Monitor Parts

Table 4-1 lists the major replaceable parts.

Individual parts that comprise the add-on kits are detailed in the Appendix corresponding to that card.

Returning Equipment

Before returning equipment to FTCA, call Technical Support at 1-800-821-5825 for a Return Material Authorization (RMA) number.

Repackaging

Equipment must be returned in a container that provides maximum protection during shipping and handling. If the original cartons and packaging material are no longer available, package the RTU *separately* from other components.

FTM 5003 RTU

Package and ship the RTU on its back (door opens upward). Pad it so that the mounting brackets cannot penetrate the box during shipment and so that the door lock tabs do not get bent. Box each RTU separately using a double thickness cardboard container and adequate padding. Do not drop. Use appropriate warning labels on the outside of the container.

Table 4-1 FTM 5003 Major Replaceable Parts

Item	Description	Part Number
5100	Power Supply Board	2510001
5110	CPU Card	2511001
	Battery	4991875
	Varistor	6901079
TB1	Terminal Strip, 3 pos	1903677
F1	Fuse, .5 amp 3AG	4900290
SW1	Switch, interlock	4903400

Table 4-1 FTM 5003 Major Replaceable Parts

Item	Description	Part Number
	Cardguide	4903398
	Locking Cardguide	4903399
	Screw Clamp, #8-32 x 3/8, ground	5901945
F1	Fuse Holder	4900377
5105	Backplane Board	2510501
5107	Backplane Extender Board	2510701

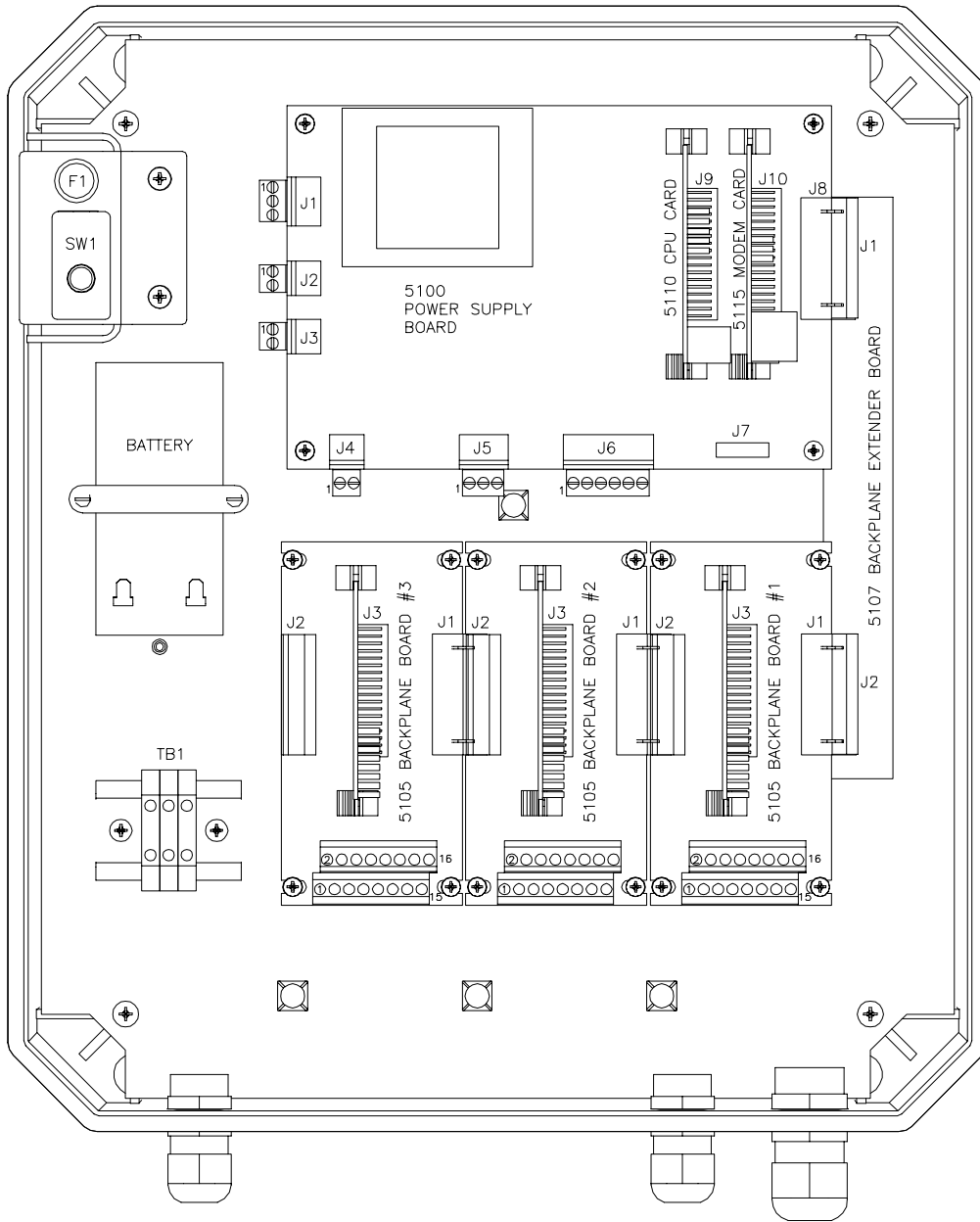

Figure 4-1 FTM 5003 Component Locations

This page left intentionally blank.

Appendix A

5115 Modem Card

5115 Modem Card and Telephone Line: “Bell” wire is the recommended external telephone connection to J2 at terminals 1 and 2 on the 5115 Modem Card. As an alternative, the RJ11 socket, J3, may instead be used. (see *Figure A-1*). This connection to a remote PC computer running Flash Technology’s EAGLE

Software allows the remote set up and monitoring to take place. The 5115 Modem Card should be connected to J10 of the 5100 Power Supply Board. Also, the ring terminal of a ground wire soldered to the *EARTH* point on the 5115 board must be seated under the upper right mounting screw of the 5100 Power Supply Board. *Table A-1* lists the functions of the LEDs on the 5115 card.

Table A-1 5115 Modem Card LED Descriptions

Item	Description
LED I1	RX - Modem Receive Data
LED I2	TX - Modem Transmit Data
LED I3	DCD - Modem Carrier Detect

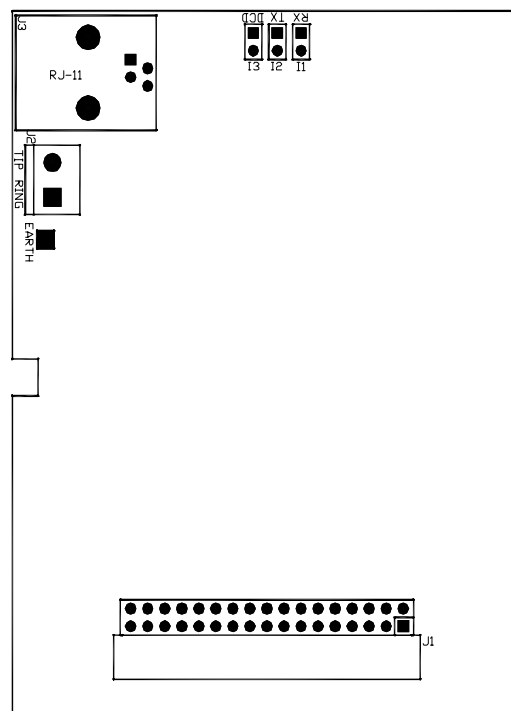

Figure A-1 5115 Modem Card

Ordering Parts

is made up of the individual parts listed in *Table A-2*.

The modem card comes as part of the Modem Card Kit, FTC part number 1903500. The kit

Table A-2 Modem Card Kit, FTC #1903500

Item	Description	Part Number	Qty
5115	Modem Card	2511501	1
	Cardguide	4903398	1
	Locking Cardguide	4903399	1

Appendix B

5120 Light Monitoring Card

5120 Light Monitoring Card: The 5120 card is used for monitoring current sensor inputs connected to a light monitoring system. The card has a maximum input of 3 strobes, 3 beacons, and 2 tiers of marker lights. If more than the maximum is needed, additional 5120 cards can be used. There is an addressing scheme for the cards if more than one is used in a system so that each card will have a unique address. If two similar cards are present with the same address, only one will be recognized at a time and neither will provide reliable data. The cards do not have to be in order of their address in relation to how they are plugged into the system. This addressing scheme is defined in *Table B-1*.

Standard Data Points of the 5120 Light Monitoring Card: The current sensor wires are connected to J4 of the 5105 board (see *Figure B-1*). Once current sensors are connected to the 5120 card, the particular configuration must be setup through EAGLE. This would include specifying the number of strobes, beacons, and markers and what type of bulb they use (incandescent or halogen). There is a status LED for each input as well as an overall board status LED (see *Table B-2*). If the board is communicating properly with the system, the Board Status LED will be green. Other-

wise, it will be off. When the FTM 5000 is powered on, the Status LED will be off until the card is initialized, after which it will be on continuously. The input status LEDs can be one of 3 colors:

- Green - Indicates the presence of current regardless of how the system is setup through EAGLE. The LED will also be green if the the system is configured for that particular input and the current detected is within the proper levels.
- Red - The light is supposed to be operating but there is no current detected for it. This will only occur for an input that is configured to exist through EAGLE.
- Yellow - There is some current detected for the light but it is not operating at the defined level. For example: if a tier of markers has 3 marker lights but only two are operating, the status LED will be yellow.

When the FTM 5000 is powered on, all of the input status LEDs will come on (first yellow and then red) until the board is initialized, after which they will go off unless they are indicating status.

See *Figure B-2* for LED and switch locations.

Table B-1 Card Addressing Scheme

SW1-1	SW1-2	SW1-3	SW1-4	Address
ON	ON	ON	ON	1
OFF	ON	ON	ON	2
ON	OFF	ON	ON	3
OFF	OFF	ON	ON	4
ON	ON	OFF	ON	5
OFF	ON	OFF	ON	6
ON	OFF	OFF	ON	7
OFF	OFF	OFF	ON	8

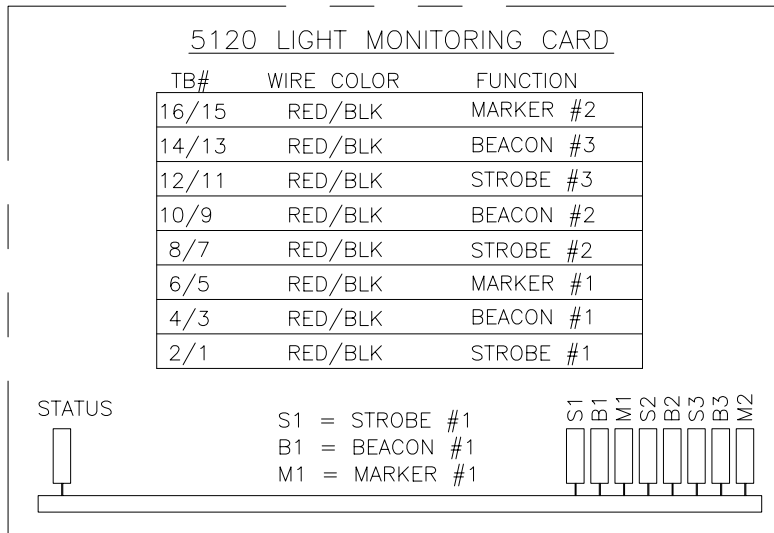

Figure B-1 5120 Light Monitoring Card Terminal Block Labels

Table B-2 5120 Light Monitoring Card LED Descriptions

Item	Description
LED I1 - Status	Board Status
LED I2 - M2	Marker 2 Status
LED I3 - B3	Beacon 3 Status
LED I4 - S3	Strobe 3 Status
LED I5 - B2	Beacon 2 Status
LED I6 - S2	Strobe 2 Status
LED I7 - M1	Marker 1 Status
LED I8 - B1	Beacon 1 Status
LED I9 - S1	Strobe 1 Status

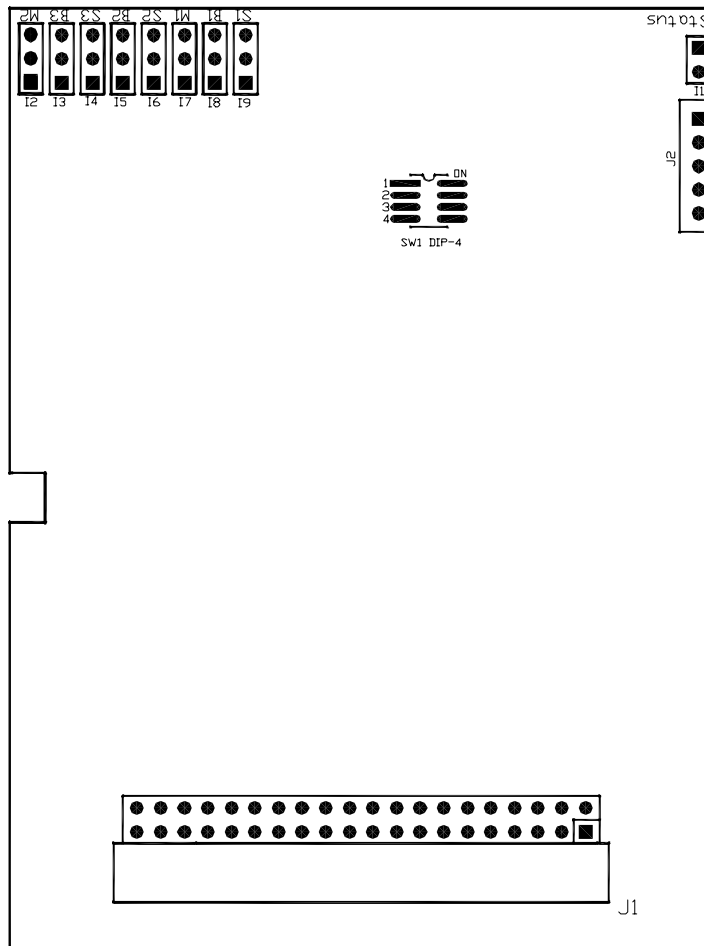

Figure B-2 5120 Light Monitoring Card

Mounting

The 5120 card should be connected to J3 of a 5105 backplane board that is in turn connected to J8 of the 5100 Power Supply Board, either directly or indirectly thorough other 5105 boards.

Photocell Sensor

Mounting and outline dimensions for the photocell sensor are shown in *Figure B-3*

Use the following guidelines for the photocell:

- Locate the photocell where it has an unobstructed view of the polar sky.
- It must not view direct or reflected artificial light.

- The photocell may be supported directly by screws or tie-wrap, or on electrical conduit.
- Protect from falling ice.
- Using proper procedures, wiring may be extended if necessary.
- *Mount the photocell vertically on the top end of a vertical length of conduit to prevent water from entering and damaging the unit.*

Installation

Wiring

Photocell Sensor Wiring

Use the provided “SO” #16 AWG cable for each. These are provided with the FTM 5000 Light Monitoring Kit for photocell sensor connection.

Connect the white photocell wire to J4-1 and the black photocell wire to J4-2 on the 5100 Power Supply Board.

Mode Relay Wiring

Use a provided 2-conductor #16 AWG cable for mode relay connection. The mode relay connections are fastened from J5-1 to J5-2 on the 5100 Power Supply Board for N/O (normally open) operation, or from J5-2 to J5-3 for N/C (normally closed operation). The normal state is shown for day mode operation; these contacts switch state when the unit is in night mode. The contacts are electrically isolated and intended to switch control circuits but not power circuits. The use of normally closed or normally open contacts depend on the requirements of the unit to which the contacts are connected. ***Do not use these contacts to transfer power source lines.*** Their rating is 120 Volts 10 Amps.

Current Sensors

Install current sensors on the power supply wire of the circuit to be sensed. The wire is inserted through the sensor “donut” hole (in most cases the arrow points toward the load)

and the sensor is secured in place on the wire using a single small tie-wrap inserted through the hole capturing both the sensor and the wire. The black wire of a twisted pair sensor cable attaches to sensor terminal #1, the red wire attaches to sensor terminal #2. Each pair of the supplied cable is number printed to aid hook-up.

For Strobe Lights: *For example,* place the current sensor around the anode wire to the flash head. The other end of that particular twisted-pair connects to J4-1 and J4-2, J4-7 & J4-8, J4-11 & J4-12 (Strobe #1, #2, or #3) as appropriate for the location of the strobe light.

The connections for the Strobe sensors are polarity sensitive. The positive wire (usually Red) will correspond with even numbered terminal positions.

In dual flash head systems that use two anode wires and one cathode wire, place the current sensor on the cathode wire with the arrow pointing away from the flash head.

In most cases, connect each current sensor on the anode wire to each flash head. When connecting the sensor to the anode wire, the arrow on the sensor should point toward the flash head. In rare cases when it is necessary to connect the sensor wire to the cathode, the arrow in the sensor should point away from the flash head.

For Beacons: Connect the current sensor on the power line to each beacon.

For Marker Tiers: Connect the current sensor on the power line to each marker tier.

The FTM 5000 calculates and reports status based on the use of two 620 Watt beacon bulbs and a 116 Watt marker bulb if it is setup in EAGLE for incandescent bulbs. If EAGLE is setup for halogen bulbs, the calculation is based on 420 Watts for a single beacon and 40 Watts for a marker (approximately 1/3 the rated power of incandescent). **Double or Triple looping of current sense toroids is not**

necessary to obtain the correct measurement if setup correctly.

Troubleshooting

Photocell

If the photocell hasn't changed state in 19 hours, unless the alarm has been disabled in EAGLE, the red PEC LED (I4) on the 5110 CPU card will come on. Check that the FTM 5000 is operating correctly by unplugging the J4 connector on the 5100 Power Supply Board and then either short the pins together on J4 or JP1. There will be a 10 second delay before the mode would normally change. If the mode changes, then check the photocell connections and replace if necessary.

Current Sensors

When a current sensor is connected to the Light Monitoring Board, the status LED for that input will light if current is detected by the sensor, regardless of how the system is configured through EAGLE. The system configuration will determine what color the LED will be:

- Red - Current is expected but there is none present. Check to make sure the light controller is operating and that the light is

coming on. Check to make sure that the polarity is correct. You can also connect the sensor to another input of the same type and see if the corresponding LED lights up (should light up green if previously unused) to check that the sensor is working.

- Green - Indicates that a current level is detected and within the specified limits as set in EAGLE. If no limits are set, the LED will still be green.
- Yellow - Means that the system is configured for this input and receiving some current signal but is not operating within the specified limits. Check to see that all lights are on and that the limits are set correctly through EAGLE. Also, check that the right bulb type (incandescent or halogen) is selected for the system.

Ordering Parts

The Light Monitoring Card comes as part of a Light Monitoring Card Kit, FTC part numbers 1903501 & 1903503. The 1903501 kit is for a single beacon system and the 1903503 kit is for a triple beacon system. The only difference between the two is that the triple beacon kit has 8 current sensors rather than 3. The kits are made up of the individual parts listed in *Table B-3*.

Table B-3 Light Monitoring Card Kit, FTC #1903501 & 1903503

Item	Description	Part Number	Qty
5120	Light Monitoring Card	2512001	1
	Cardguide	4903398	1
	Locking Cardguide	4903399	1
5105	Backplane Board	2510501	1
	Screw, #6-32 x 1/4" s.s.	5900735	4
	Standoff, 1" M/F Hex s.s.	5903348	4
	Infocard Label	3899101	1

Table B-3 Light Monitoring Card Kit, FTC #1903501 & 1903503

Item	Description	Part Number	Qty
	Screw Clamp, #8-32 x 3/8, ground	5901945	1
	Photocell sensor	1855001	1
	Current Sensor	1878903	3 for 1903501 8 for 1903503

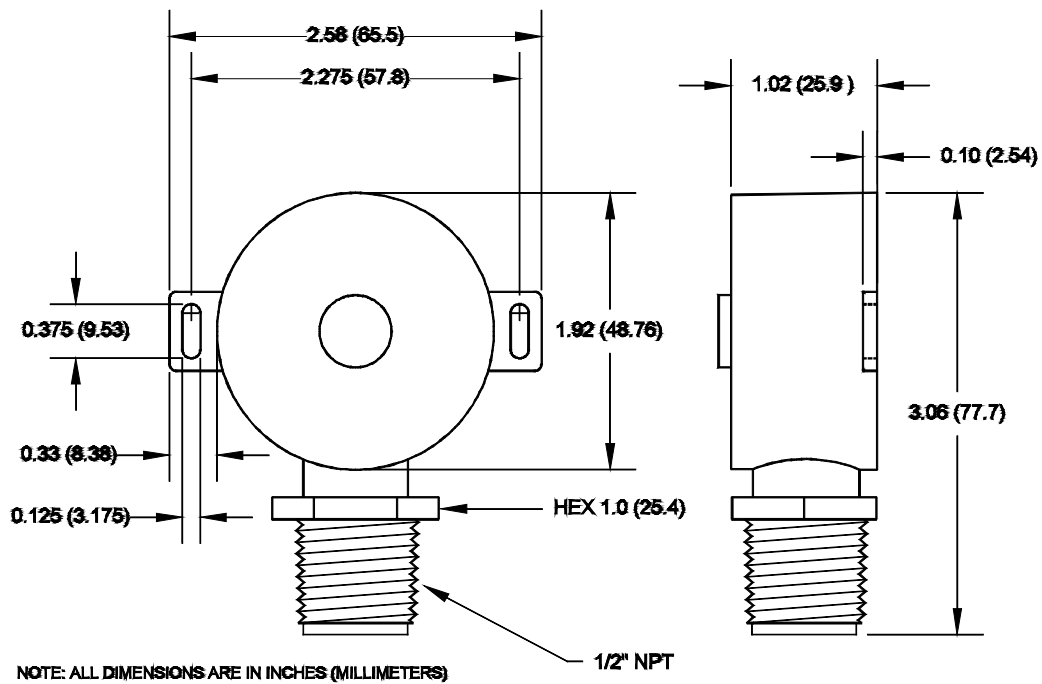
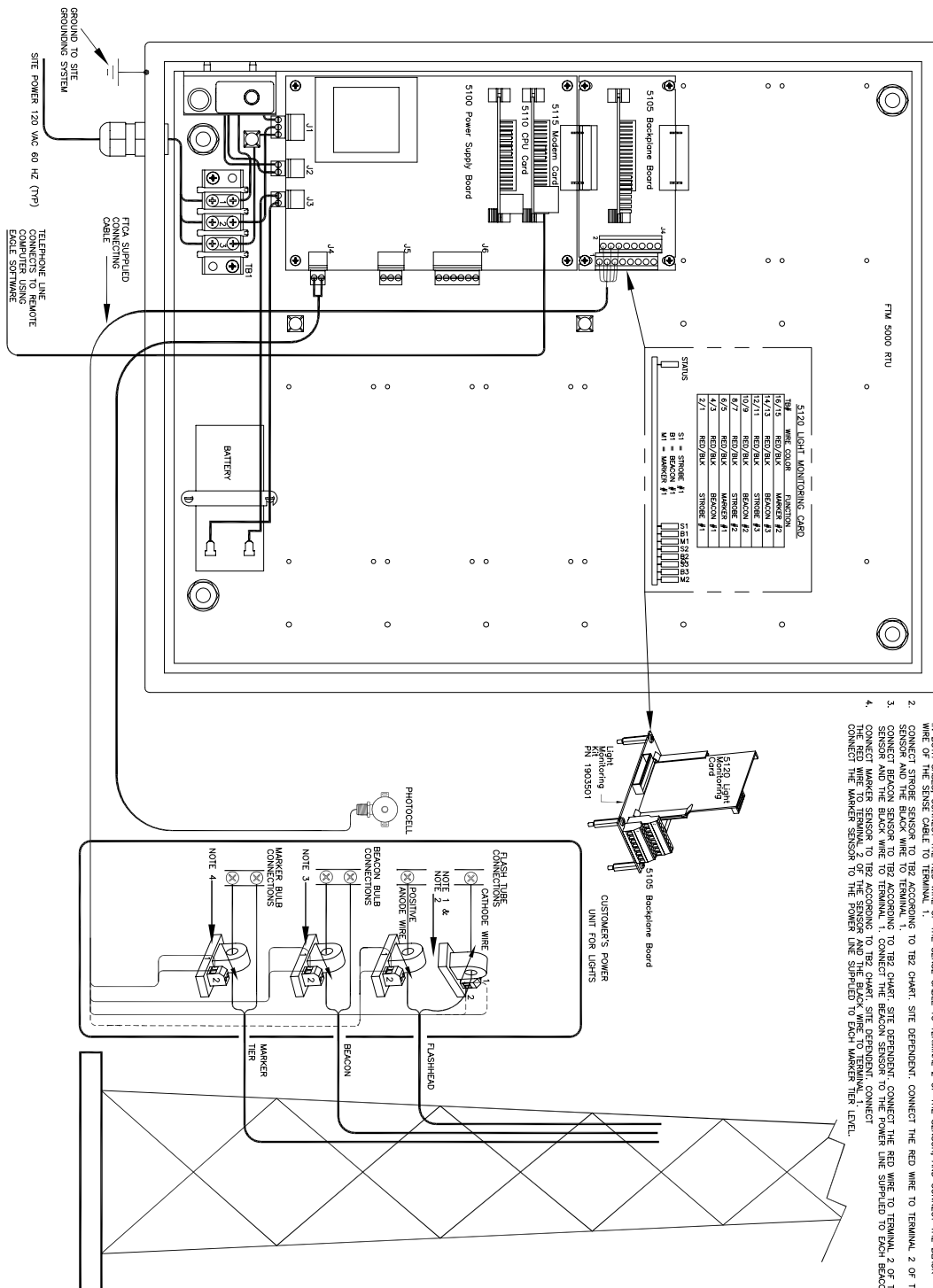

Figure B-3 Photocell Sensor Mounting and Outline



- NOTES:
1. IN MOST CASES, PLACE THE CURRENT SENSOR ON THE ANODE WIRE OF THE FLASH TUBE. IN THESE CASES, THE ARROW ON THE CURRENT SENSOR CATHODE SHOULD FACE IN THE DIRECTION OF THE FLASHHEAD. IF THE SENSOR MUST BE PLACED ON THE CATHODE WIRE IN BOTH CASES, THE CURRENT SENSOR SHOULD BE PLACED ON THE CATHODE WIRE OF THE FLASH TUBE. ALSO, CONNECT THE BLACK WIRE OF THE SENSE CABLE TO TERMINAL 1.
 2. CONNECT STROBE SENSOR TO T82 ACCORDING TO T82 CHART. SITE DEPENDENT. CONNECT THE RED WIRE TO TERMINAL 2 OF THE SENSOR AND THE BLACK WIRE TO T82 ACCORDING TO T82 CHART. SITE DEPENDENT. CONNECT THE BEACON SENSOR TO THE POWER LINE SUPPLIED TO EACH BEACON.
 3. CONNECT MARKER SENSOR TO T82 ACCORDING TO T82 CHART. SITE DEPENDENT. CONNECT THE BEACON SENSOR TO THE POWER LINE SUPPLIED TO EACH MARKER TIER LEVEL.
 4. CONNECT THE MARKER SENSOR TO THE POWER LINE SUPPLIED TO EACH MARKER TIER LEVEL.

Figure B-4 FTM 5000 Light Monitoring Installation

Page left intentionally blank.

Appendix C

5125 Dry Contact Card

5125 Dry Contact Card: The 5125 card is used for monitoring dry contact closure inputs. The card has a maximum of 8 contact inputs. If more than the maximum is needed, additional 5125 cards can be used. There is an addressing scheme for the cards if more than one is used in a system so that each card will have a unique address. If two similar cards are present with the same address, only one will be recognized at a time and neither will provide reliable data. The cards do not have to be in order of their address in relation to how they are plugged into the system. This addressing scheme is defined in *Table C-1*.

Standard Data Points of the 5125 Dry Contact Card: The dry contact wires are connected to J4 of the 5105 board (see *Figure B-1*). Once the dry contacts are connected to the 5125 card, the particular configuration must be setup through EAGLE. The dry contact inputs can be labeled as to what the contact represents (type of equipment) and what the two states represent (opened and closed). For example, dry contact #1 can be labeled “Generator” and the closed state labeled “Running”, with the open state labeled “Off”. An alarm condition can be set based on the state of the dry contact. There is a status LED for each input as well as an overall board Status LED and Fault LED (see *Table C-2*). If the board is communi-

cating properly with the system, the Board Status LED will be green. Otherwise, it will be off. When the FTM 5000 is powered on, the Status LED will be off until the card is initialized, after which it will be on continuously. The input status LEDs can be one of 3 colors:

- Green - Indicates the presence of a contact closure.
- Red - Represents that the dry contact input is OPEN and is in alarm based on the EAGLE setup.
- Yellow - Represents that the dry contact input is CLOSED and is in alarm based on the EAGLE setup.

When the FTM 5000 is powered on, all of the input status LEDs will come on (first yellow and then red) until the board is initialized, after which they will go off unless they are indicating status. No color means an open contact and no alarm.

The Fault LED indicates that a voltage has been applied to a dry contact input. **Do Not apply a voltage with a current load across the dry contact input terminals, this will result in a board failure.**

See *Figure C-2* for LED and switch locations.

Table C-1 Card Addressing Scheme

SW1-1	SW1-2	SW1-3	SW1-4	Address
ON	ON	ON	ON	1
OFF	ON	ON	ON	2
ON	OFF	ON	ON	3
OFF	OFF	ON	ON	4
ON	ON	OFF	ON	5
OFF	ON	OFF	ON	6
ON	OFF	OFF	ON	7
OFF	OFF	OFF	ON	8

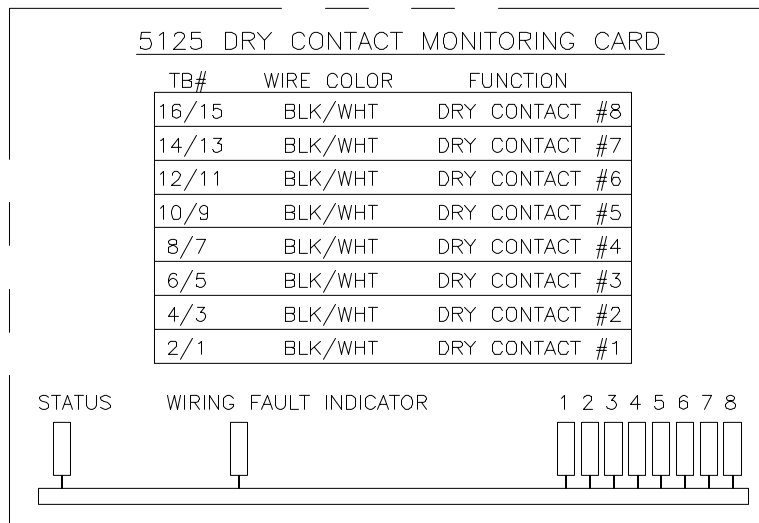

Figure C-1 5125 Dry Contact Card Terminal Block Labels

Table C-2 5125 Dry Contact Card LED Descriptions

Item	Description
LED I1	Board Status
LED I2	Dry Contact #1
LED I3	Dry Contact #3
LED I4	Dry Contact #2
LED I5	Dry Contact #4
LED I6	Dry Contact #8
LED I7	Dry Contact #7
LED I8	Dry Contact #5
LED I9	Dry Contact #6
LED I10	Fault

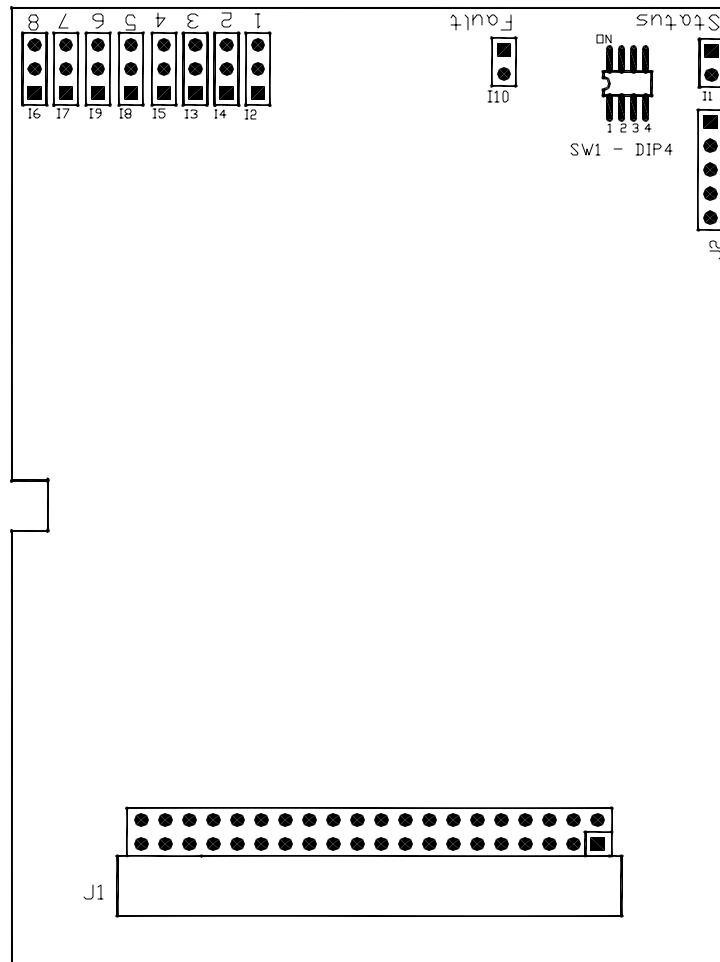

Figure C-2 5125 Dry Contact Card

Mounting

The 5125 card should be connected to J3 of a 5105 backplane board that is in turn connected to J8 of the 5100 Power Supply Board, either directly or indirectly through other 5105 boards.

Troubleshooting

If the card is not reporting a contact closure, disconnect the wires for that input and measure the continuity between them with a multi-meter to verify that there is a contact closure. Apply the input to another set of terminals to see if the status LED of that input lights up. If it does, then it is likely that the previous input was damaged and the board should be replaced.

If the Fault LED is illuminated, there has been a voltage applied to one of the inputs

causing the entire card to shut down. It is possible that the card could now be damaged as well. Using a multimeter, check each input for presence of a voltage to determine which input needs to be corrected. Replace card if necessary.

Ordering Parts

The 5125 Dry Contact Card comes as part of a Dry Contact Card Kit, FTC part number 1903502. The kits are made up of the individual parts listed in *Table C-3*.

Table C-3 5125 Dry Contact Card Kit, FTC #1903502

Item	Description	Part Number	Qty
5125	Dry Contact Card	2512501	1
	Cardguide	4903398	1
	Locking Cardguide	4903399	1
5105	Backplane Board	2510501	1
	Screw, #6-32 x 1/4" s.s.	5900735	4
	Standoff, 1" M/F Hex s.s.	5903348	4
	Infocard Label	3899102	1
	Screw Clamp, #8-32 x 3/8, ground	5901945	1

Appendix D

5121 Bank Voltage Card

5121 Bank Voltage Card: The 5121 card is used for monitoring 1 temperature and 6 bank voltage inputs. The card has a maximum of 7 inputs. If more than the maximum is needed, additional 5121 cards can be used. There is an addressing scheme for the cards if more than one is used in a system so that each card will have a unique address. If two similar cards are present with the same address, only one will be recognized at a time and neither will provide reliable data. The cards do not have to be installed in order of their address in relation to how they are plugged into the system. This addressing scheme is defined in *Table D-1*.

Standard Data Points of the 5121 Bank Voltage Card: The temperature and bank voltage sensor wires are connected to J4 of the 5105 board (see *Figure D-1*). Once the sensors are connected to the 5121 card, the particular configuration must be setup through EAGLE. The 5121 card is intended to monitor both the day and night capacitor bank for a particular power converter and up to 3 converters for a total of 6 bank voltage inputs. The temperature and bank voltage levels can be configured as to what levels constitute an alarm. There is a status LED for each input as well as an overall board Status LED (see *Table D-2*). If the board is communicating properly with

the system, the Board Status LED will be green. Otherwise, it will be off. When the FTM 5000 is powered on, the Status LED will be off until the card is initialized, after which it will be on continuously. The input status LEDs can be one of 3 colors:

- Green - Indicates the presence of a bank voltage sensor but not necessarily a bank voltage being measured by the sensor. The temperature status LED will be green if the temperature sensor is connected
- Red - Represents that the bank voltage sensor is not communicating and may or may not indicate the absence of a bank voltage. The temperature status LED will only be red if the sensor is not connected and set to alarm at a certain temperature.
- Yellow - Represents that the bank voltage or temperature sensor is present and is in alarm based on the EAGLE setup for bank voltage or temperature level.

When the FTM 5000 is powered on, all of the input status LEDs will come on (first green and then either red or amber) until the board is initialized, after which they will indicate status. No color means nothing is connected to that input and no alarm exists.

See *Figure D-2* for LED and switch locations.

Table D-1 Card Addressing Scheme

SW1-1	SW1-2	SW1-3	SW1-4	Address
ON	ON	ON	ON	1
OFF	ON	ON	ON	2
ON	OFF	ON	ON	3
OFF	OFF	ON	ON	4
ON	ON	OFF	ON	5
OFF	ON	OFF	ON	6
ON	OFF	OFF	ON	7
OFF	OFF	OFF	ON	8

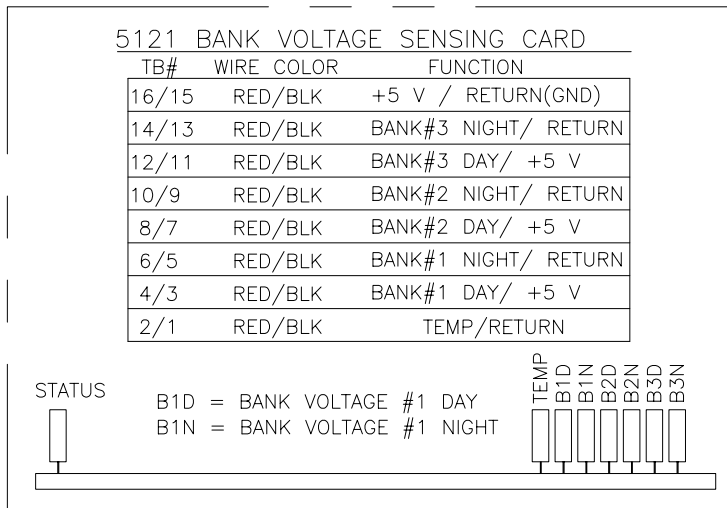

Figure D-1 5121 Bank Voltage Card Terminal Block Labels

Table D-2 5121 Bank Voltage Card LED Descriptions

Item	Description
LED I1	Board Status
LED I2	Temperature
LED I3	Bank Voltage #1 Day
LED I4	Bank Voltage #1 Night
LED I5	Bank Voltage #2 Day
LED I6	Bank Voltage #2 Night
LED I7	Bank Voltage #3 Day
LED I8	Bank Voltage #3 Night

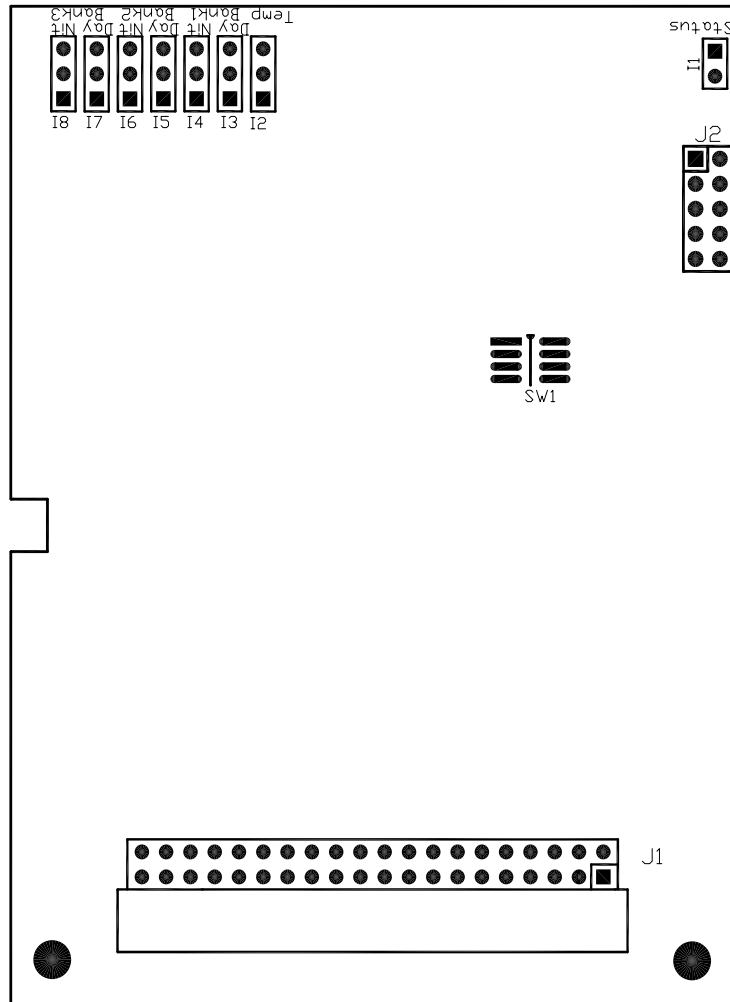

Figure D-2 5121 Bank Voltage Card

Mounting

The 5121 card should be connected to J3 of a 5105 backplane board that is in turn connected to J8 of the 5100 Power Supply Board, either directly or indirectly through other 5105 boards.

Troubleshooting

Verify that the card Status LED indicates correct communication of the board with the system. When the FTM 5000 is powered on, the Status LED should be Off until the card is initialized (several seconds), after which it will be On continuously. If this does not occur, check that the card's Address Switch SW1 is set to a unique address (see Table D-1). No other Bank Voltage card in the FTM-5000

should have the same address. If correct communication cannot be established, replace the Bank Voltage Card.

Verify that the card input status LED's indicate the correct input state. See the previous description of LED states. If the input status LED is red indicating a sensor communication problem, check all connections both at the 5105 board and at the bank voltage sensor. Try connecting the bank voltage sensor to another input to test if the sensor or Bank Voltage Card input is bad. If the input is bad, replace the Bank Voltage Card. If the input status LED is green indicating correct sensor communication but the input does not seem to be indicating correctly, measure the bank voltage at the sensor using a Voltmeter and verify

correct levels. If the input status LED is yellow indicating an alarm, check the settings in EAGLE for bank voltage or temperature level.

Ordering Parts

The 5121 Bank Voltage Card comes as part of either a single or triple beacon Bank Voltage Card Kit, FTC part number 1903620 for single, 1903630 for a triple. The kits are made up of the individual parts listed in *Table D-3*.

Table D-3 5121 Bank Voltage Card Kits, FTC #1903620,1903630

Item	Description	Part Number	Qty
5121	Bank Voltage Card	2512101	1
	*Bank Voltage Sensor	1878904	2 or 6
	Cardguide	4903398	1
	Locking Cardguide	4903399	1
5105	Backplane Board	2510501	1
	Screw, #6-32 x 1/4" s.s.	5900735	4
	Standoff, 1" M/F Hex s.s.	5903348	4
	Infocard Label	3899104	1
	Screw Clamp, #8-32 x 3/8, ground	5901945	1
	**Temperature Sensor	1878901	1

* Qty 2 for a single beacon kit, qty 6 for a triple

** Temperature sensor is purchased separately from the kits.

Appendix E

5130 Relay Output Card

5130 Relay Output Card: The 5130 card is used to provide relay outputs for various uses. The card has (4) Form-C (NO-C-NC) relays(1-4) (Rated Nominal: 2 amps 30 VDC, 0.5 amps 125 VAC, Resistive load. MAX: 0.3 amps 220 VDC Resistive load) and (2) Form-A (NO) solid state relays(5,6) (Rated 0.4 Amps, 60 VDC/VAC). If more than the maximum is needed, additional 5130 cards can be used. There is an addressing scheme for the cards if more than one is used in a system so that each card will have a unique address. If two similar cards are present with the same address, only one will be recognized at a time and neither will provide reliable data. The cards do not have to be in order of their address in relation to how they are plugged into the system. This addressing scheme is defined in *Table E-1*.

Standard Data Points of the 5130 Relay Output Card: The output wires are connected to J4 of the 5105 board (see *Figure E-1*). Once the outputs are connected to the 5130 card, the particular configuration must be setup through EAGLE. Each state of the relay can be labeled separately and independently driven based on the customer's needs. There is a status LED for each output as well as an overall board Status LED (see *Table E-2*). If the board is communicating properly with the system, the Board Status LED will be green. Otherwise, it will be off. When the FTM 5000 is powered on, the Status LED will be off until the card is initialized, after which it will be on continuously. When the FTM 5000 is powered on, all of the output status LEDs will come on until the board is initialized, after which they will indicate relay status. The output status LEDs will be green if that particular relay is energized.

See *Figure E-2* for LED and switch locations.

Table E-1 Card Addressing Scheme

SW1-1	SW1-2	SW1-3	SW1-4	Address
ON	ON	ON	ON	1
OFF	ON	ON	ON	2
ON	OFF	ON	ON	3
OFF	OFF	ON	ON	4
ON	ON	OFF	ON	5
OFF	ON	OFF	ON	6
ON	OFF	OFF	ON	7
OFF	OFF	OFF	ON	8

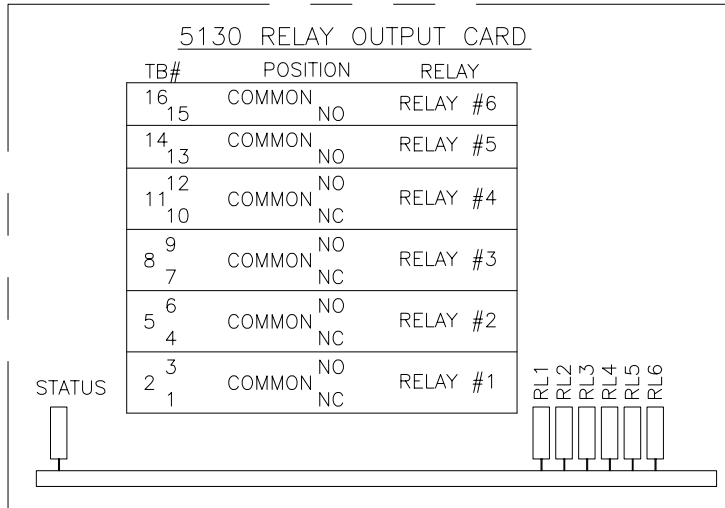

Figure E-1 5130 Relay Output Card Terminal Block Labels

Table E-2 5130 Relay Output Card LED Descriptions

Item	Description
LED I1	Board Status
LED I2	Relay #1
LED I3	Relay #2
LED I4	Relay #3
LED I5	Relay #4
LED I6	Relay #5
LED I7	Relay #6

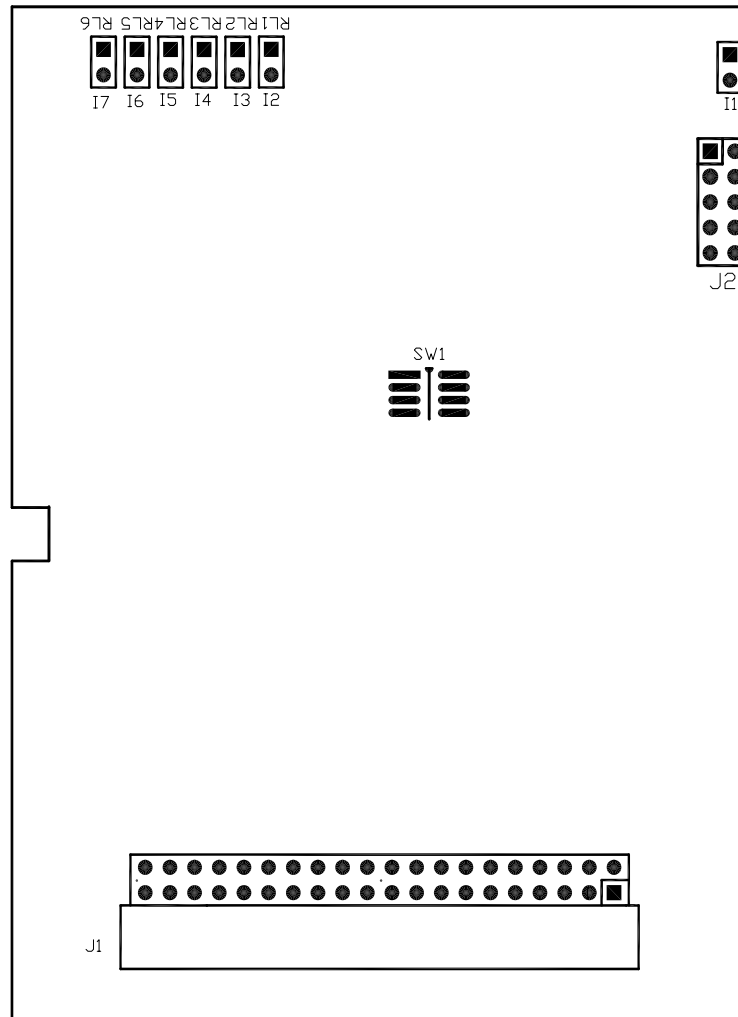

Figure E-2 5130 Relay Output Card

Mounting

The 5130 card should be connected to J3 of a 5105 backplane board that is in turn connected to J8 of the 5100 Power Supply Board, either directly or indirectly through other 5105 boards.

Troubleshooting

Verify that the card Status LED indicates correct communication of the board with the system. When the FTM 5000 is powered on, the Status LED should be Off until the card is initialized (several seconds), after which it will be On continuously. If this does not occur, check that the card's Address Switch SW1 is set to a unique address (see Table E-1). No other Relay card in the FTM-5000 should have the same

address. If correct communication cannot be established, replace the Relay Output Card.

Verify that the card output status LED's indicate the correct relay status. The LED's are off if the relay is deenergized and Green if energized. If the state of the LED is not correct, check the relay settings in EAGLE. If the output status LED state is correct but the relay does not seem to be operating correctly, verify the relay state with an Ohmmeter. Connect the Ohmmeter leads to the screw-heads on the 5105 terminal strip J4 (see Figure E-1). If the relay is energized, continuity (0 Ohms) should exist between COMMON and NO and no continuity should exist between COMMON and NC. If the Ohmmeter readings are incorrect, replace the Relay Output Card. If

the Ohmmeter readings are correct but there is still a problem, verify the wiring from the 5105 terminal strip J4.

Ordering Parts

The 5130 Relay Output Card comes as part of a Relay Output Card Kit, FTC part number 1903621. The kit is made up of the individual parts listed in *Table E-3*.

Table E-3 5130 Relay Output Card Kit, FTC #1903621

Item	Description	Part Number	Qty
5130	Relay Output Card	2513001	1
	Cardguide	4903398	1
	Locking Cardguide	4903399	1
5105	Backplane Board	2510501	1
	Screw, #6-32 x 1/4" s.s.	5900735	4
	Standoff, 1" M/F Hex s.s.	5903348	4
	Infocard Label	3899103	1
	Screw Clamp, #8-32 x 3/8, ground	5901945	1

Appendix F

5123 Analog Input Card

5123 Analog Input Card: The 5123 card is used for monitoring 1 temperature and 6 analog inputs. The card has a maximum of 7 inputs. If more than the maximum is needed, additional Analog Input cards can be used. There is an addressing scheme for the cards if more than one is used in a system so that each card will have a unique address. If two similar cards are present with the same address, only one will be recognized at a time and neither will provide reliable data. The cards do not have to be installed in order of their address in relation to how they are plugged into the system. This addressing scheme is defined in *Table F-1*.

Standard Data Points of the 5123 Analog Input Card: The temperature sensor and analog input wires are connected to J4 of the 5105 Backplane board (see *Figure F-1*). The analog inputs accept both voltage (5VDC max.) and current (4-20mA) type signals. Connect the positive wire to 'Signal' and the negative wire to any 'Return' terminal (not +5V). For connection of current type signals, a resistor must be connected between the 'Signal' and 'Return' terminals to convert the current to a voltage signal. The value of this resistor determines the voltage which will be measured at the maximum input current. For example, use of a 249 Ohm 1/4W 1% resistor gives a voltage of 5V with a current of 20mA ($R=V/I$).

Once the sensors are connected to the Analog Input card, the particular configuration must

be setup through EAGLE. The temperature and analog input levels can be configured as to what levels constitute an alarm.

There is an overall board Status LED as well as a status LED for each input (see *Table F-2*). If the board is communicating properly with the system, the Board Status LED will be green. Otherwise, it will be off. When the FTM 5000 is powered on, the board Status LED will be off until the card is initialized, after which it will be on continuously.

The seven input status LED's can be one of 3 colors or off. When the FTM 5000 is powered on, all of the input status LED's will come on (first green and then either red or amber) until the board is initialized, after which they will indicate status. The status is determined by the input connected and by the Eagle setup for voltage or temperature level.

- Green - Indicates that a sensor is connected and that the input is not in alarm
- Red - Indicates that a sensor is not connected (or is connected and providing zero volts) and the input is in alarm.
- Yellow - Indicates that a sensor is connected and that the input is in alarm.
- Off - Indicates that a sensor is not connected (or is connected and providing zero volts) and that the input is not in alarm.

See *Figure F-2* for LED and switch locations.

Table F-1 Card Addressing Scheme

SW1-1	SW1-2	SW1-3	SW1-4	Address
ON	ON	ON	ON	1
OFF	ON	ON	ON	2
ON	OFF	ON	ON	3
OFF	OFF	ON	ON	4
ON	ON	OFF	ON	5
OFF	ON	OFF	ON	6
ON	OFF	OFF	ON	7
OFF	OFF	OFF	ON	8

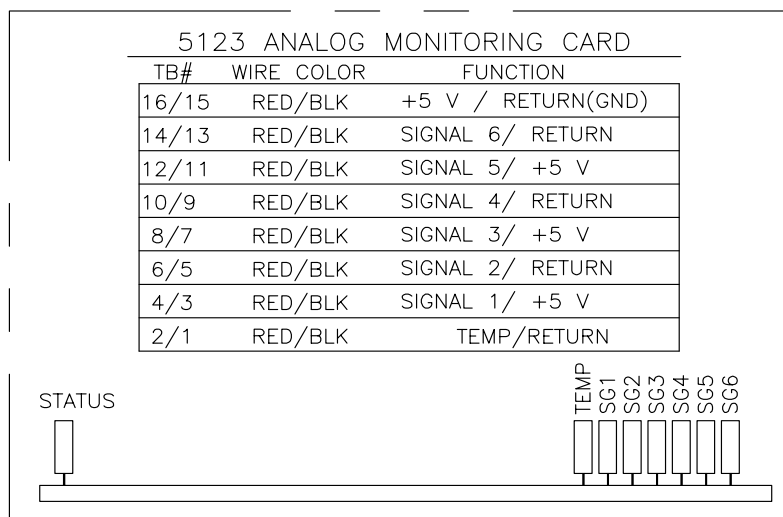

Figure F-1 5123 Analog Input Card Terminal Block Labels

Table F-2 5123 Analog Input Card LED Descriptions

Item	Description
LED I1	Board Status
LED I2	Temperature
LED I3	Analog Signal #1 (SG1)
LED I4	Analog Signal #2 (SG2)
LED I5	Analog Signal #3 (SG3)
LED I6	Analog Signal #4 (SG4)
LED I7	Analog Signal #5 (SG5)
LED I8	Analog Signal #6 (SG6)

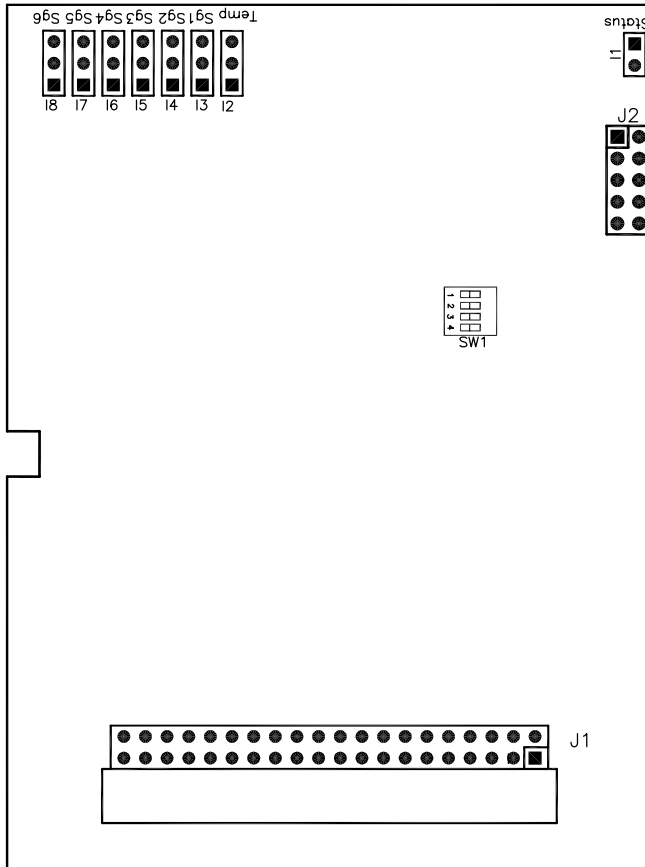

Figure F-2 5123 Analog Input Card

Mounting

The 5123 card should be connected to J3 of a 5105 backplane board that is in turn connected to J8 of the 5100 Power Supply Board, either directly or indirectly through other 5105 boards.

Troubleshooting

Verify that the card Status LED indicates correct communication of the board with the system. When the FTM 5000 is powered on, the Status LED should be Off until the card is initialized several seconds), after which it will be On continuously. If this does not occur, check that the card's Address Switch SW1 is set to a unique address (see *Table F-1*). No other 5123 Analog Input card in the FTM-5000 should have the same address. If correct communication cannot be established, replace the Card.

Verify that the card input status LED's indicate the correct input state. See the previous description of LED states. If the input status LED is red, check all connections both at the 5105 Backplane and at the sensor. Try connecting the sensor to another input to test if the sensor or 5123 Analog Input Card input is bad. If the input is bad, replace the Analog Input Card. If the input status LED is green indicating correct sensor communication but the input does not seem to be indicating correctly, measure the voltage at the sensor using a Voltmeter and verify correct levels. If the input status LED is yellow indicating an alarm, check the settings in EAGLE for voltage or temperature level.

Ordering Parts

The 5123 Analog Input Card comes as part of the Analog Monitoring Card Kit, FTC part number 1903617. The kit is made up of the individual parts listed in *Table F-3*.

Table D-3 5123 Analog Input Card Kit, FTC #1903617

Item	Description	Part Number	Qty
5123	Analog Input Card	2512301	1
	Cardguide	4903398	1
	Locking Cardguide	4903399	1
5105	Backplane Board	2510501	1
	Screw, #6-32 x 1/4" s.s.	5900735	4
	Standoff, 1" M/F Hex s.s.	5903348	4
	Infocard Label	3899105	1
	Screw Clamp, #8-32 x 3/8, ground	5901945	1

Appendix G

RS-485 to 4747 Connection

RS-485 Communication: An RS-485 serial connection is provided on the 5100 Power Supply Board that can be used to communicate directly with the 4747 Timing & Trigger Board used in various Flash Technology Power Converters. The benefit of this is that the connection provides extended information about the Power Converter that is not available through a typical light monitoring installation using a 5120 Light Monitoring Board and sensors. This eliminates the need for a 5120 Light Monitoring Board so long as the only equipment to be monitored is Flash Technology Power Converters using a 4747 Timing

& Trigger Board with the following requirements:

- Board Number 2474703
- Board Firmware Version 6.9 or higher
- Board PAL U3 Version 4 or higher

RS-485 Setup and Installation: The FTM 5000 can communicate with up to 4 Power Converters. The 4747 board in each of the Power Converters must have a unique address which is set by using dipswitch S1 on the board. Switch positions 2, 3, and 4 enable RS-485 communication and set the address as follows in *Table G-1 4747 Board Addressing Scheme*:

Table G-1 4747 Board Addressing Scheme

Address	SW#2	SW#3	SW#4
1	ON	OFF	OFF
2	OFF	ON	OFF
3	ON	ON	OFF
4	OFF	OFF	ON

A detailed wiring diagram is shown in *Figure G-1 FTM 5000 RS-485 Installation Drawing* that includes the following instructions:

- The resistive photocell PEC 510 must be connected to J4 on the 5100 Power Supply Board in the FTM 5000.
- The Mode Switch Relay must be supplied 120 VAC by connecting J5 pin 2 on the 5100 P.S. Board to TB1 L1 (input power Line 1) in the FTM 5000. J5 pin 1 on the 5100 Board must then be connected to J5 pin 4 on the 4747 Board in the Master Power Converter. ***This connection must be made separate from the serial connection so as to not mix high voltage and low voltage signal on the same cable.***
- Using a twisted-pair shielded cable (Part# 5993101), make the RS-485 connection between the FTM 5000 and the Power Converters. Connect J6 pin 1 on the 5100 P.S. Board in the FTM 5000 to J9 pin 2 on the 4747 board in the Master Power Converter. Likewise, connect J6 pin 2 to J9 pin 1 and J6 pin 3 to J9 pin 3.
- For as many Power Converters that need to be monitored, up to 4, connect similar pins on J9 for each of the 4747 boards (i.e. connect J9 pin 1 on the Master P.C. to J9 pin 1 on Slave 1 P.C. and to J9 pin 1 on Slave 2 P.C.).
- For whichever Power Converter represents the last in the chain, a terminating resistor (100-220 ohms) must be placed across pins 1 and 2 on J9 of the 4747 board. Even if

monitoring only one Power Converter, place the resistor on the Master to terminate the loop.

- The FTM 5000 must be setup from the EAGLE software to complete the installation. After connecting with EAGLE, go to the settings tab and at the bottom of the screen is the external serial port configuration section. In the box labeled “RS485 Mode” set it to “4747”. In the box labeled “485 Board” set it to the number of 4747 boards you have connected. Once you have sent the changes to the FTM 5000, a new tab or tabs will appear, one for each 4747 board. Click on the tab(s) and set the configuration for the type of system the 4747

board is in.

Ordering Parts

The parts needed to complete this installation are available in Kit #1903665, shown in *Table G-2*.

Table G-2 RS485 Installation Kit, FT #1903665

Item	Description	Part Number	Qty
	22 AWG, Twisted-Pair Shielded Cable	5993101	25 ft
	220 ohm resistor	6992036	1
	Installation Drawing	7903501	1

1. PHOTO CELL MUST BE CONNECTED TO 49 ON FTM 5000.
2. MORE BEAMS MUST BE CONNECTED TO 25 PIN 4.
3. INPUT ON MASTER UNIT MUST BE CONNECTED TO 25 ON PCB 4747.
 TO PROVIDE THIS CONNECTION, USE CABLE #993101 TO CONNECT TO 25 ON PCB 4747.
4. THE LAST POWER CONVERTOR 4747 PCB IN THE CHAIN GETS THE SIGNAL FROM THE MASTER UNIT AND PCB 4747.
 EACH 4747 MUST HAVE A UNIQUE ADDRESS. THE ADDRESS IS SETUP USING DIPSWITCH 31, POSITIONS 2, 3, AND 4. ADDRESS POSITION 2 = ADDRESS 1, POSITION 3 = ADDRESS 2, BOTH POSITIONS 2 AND 3 = ADDRESS 3, AND POSITION 4 = ADDRESS 4.
 SW1 → ON = 1
 SW2 → ON = 2
 SW3 → ON = 3
 SW4 → ON = 4
5. AFTER TROUBLESHOOTING WITH BEAMS FROM THE MASTER UNIT, AND AT THE BOTTOM OF THE SCREEN IS THE EXTERNAL SERIAL ADDRESS. THIS ADDRESS IS THE ADDRESS OF THE BOARD SET TO 4747. IN THE BOX LABELED ADDRESS BOARD SET TO THE ADDRESS OF THE BOARD YOU WANT TO SET TO 4747. YOU MUST HAVE SENT THE CHANGES TO THE FTM 5000 A NEW TAB OR TABS WILL APPEAR FOR EACH 4747 GO TO THE TAB(S) AND SET THE ADDRESS TO 4747.
6. USE CABLE #993101 TO CONNECT RS485 AND MASTER/SLAVE. INTERCONNECT TO EACH UNIT.
7. SHOWN USING PC 312 BUT CAN BE ANY SYSTEM USING PCB 4747.

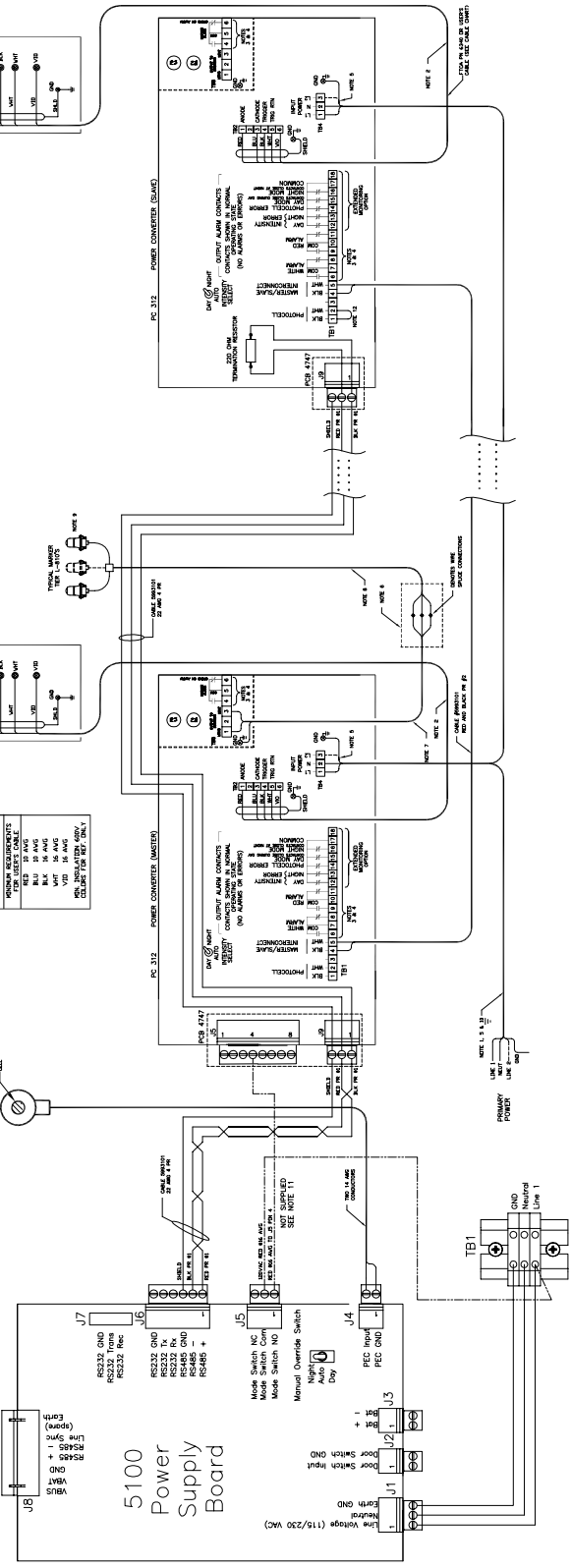

Figure G-1 FTM 5000 RS-485 Installation Drawing

Page Left Intentionally Blank.